

120x100 ALUMINIUM

12' X 6' FOLDING GOAL ELLIPTICAL ALUMINIUM

FITTING INSTRUCTION

ItsaGoal
www.itsagoal.net

COMPONENTS

A	MULTI-SURFACE ANCHOR (80)	x4	
B	GROUND PEG	x8	
C	BRASS BARREL LOCK	x2	
D	KEY	x2	
E	STANCHION NET TIES - SMALL	x8	
FXB	GOALPOST SLOT NET FIXINGS	x36	
NET	GOAL NET	x1	

POST SECTIONS

Aluminium Sections

G	LEFT SIDE FRAME	x1	
H	RIGHT SIDE FRAME	x1	
I	CROSSBAR SECTION	x1	

GROUND BACK BAR

J	BACK BAR SECTION	x1	
A	MULTI-SURFACE ANCHOR	x2	
B	GROUND PEG	x4	
FBB	QUICK RELEASE NET FIXING	x12	
RC	REAR GROUND CORNER BRACKET	x2	
BC	BLANKING CAP	x2	
DN	M10 SOCKET DOME SCREW AND HEX DOME NUT	x2	
LQ	LARGE QUICK RELEASE BUTTON	x2	

WARNING

ALL GOALS MUST BE SECURELY ANCHORED AND OR CORRECTLY COUNTER BALANCED IN ACCORDANCE WITH CURRENT GOALPOST SAFETY STANDARDS AT ALL TIMES. CONTACT THE FOOTBALL ASSOCIATION FOR THE LATEST SAFETY INFORMATION & READ OUR CARE AND MAINTENANCE DETAILS. THE GOAL MUST BE HANDLED CAREFULLY - DO NOT DRAG GOALS. DO NOT USE GOAL FRAMES WITHOUT LOCKS. GOALS MUST ALWAYS BE FULLY DISMANTLED AFTER USE. THE STANCHIONS ARE FOR SUPPORTING NET ONLY; DO NOT LIFT GOAL WITH THE STANCHIONS. LONGER PEGS ARE AVAILABLE FOR USE ON SANDY GROUND. ON GRASS, A RISK ASSESSMENT OF SOIL CONDITIONS SUITABILITY SHOULD BE CARRIED OUT WHEN ANCHORS ARE TO BE USED. ANY DAMAGE CAUSED BY MIS-USE IS NOT COVERED UNDER THE GUARANTEE.

GOALPOST SLOT NET FIXINGS FOR THE CROSSBAR & UPRIGHTS

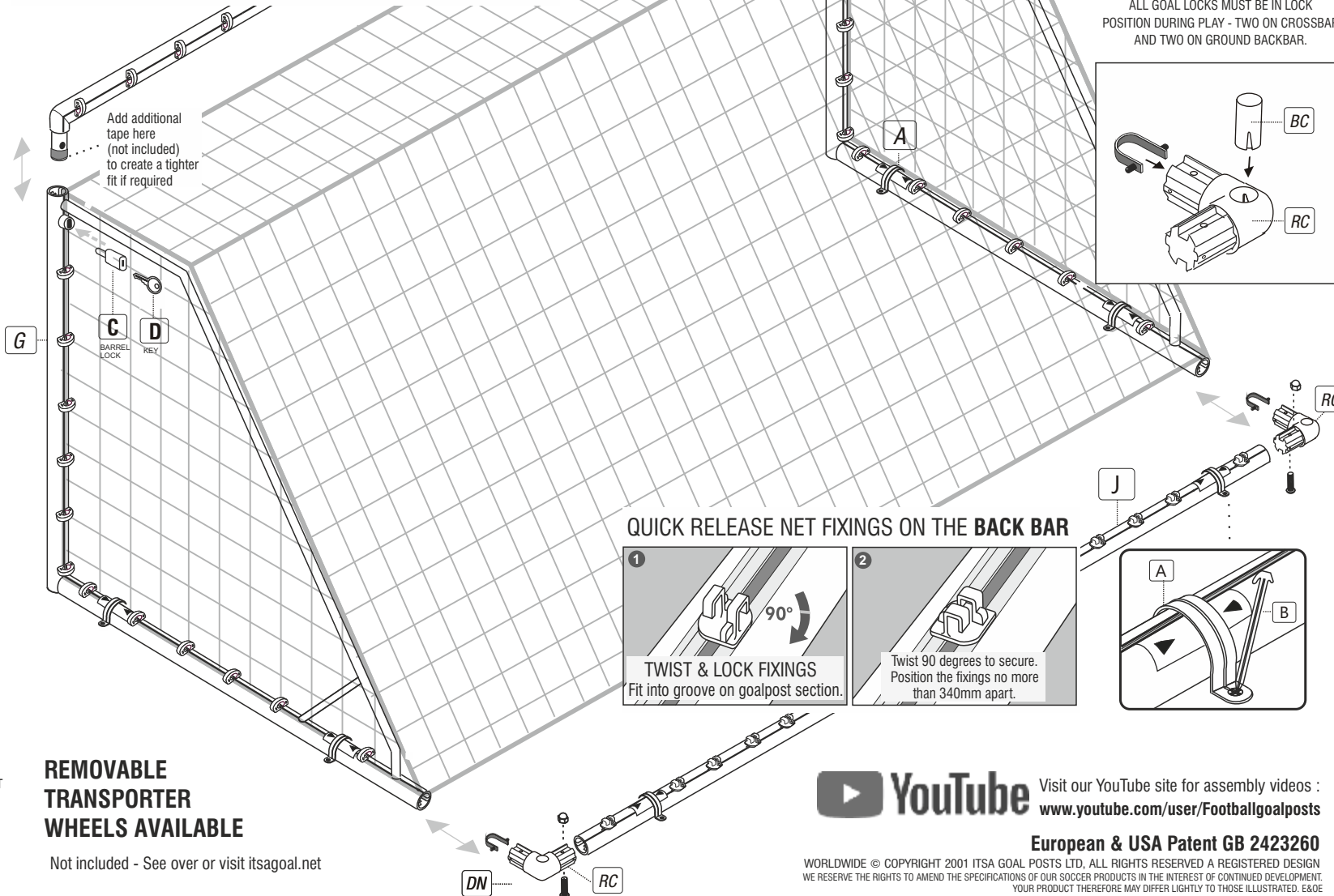
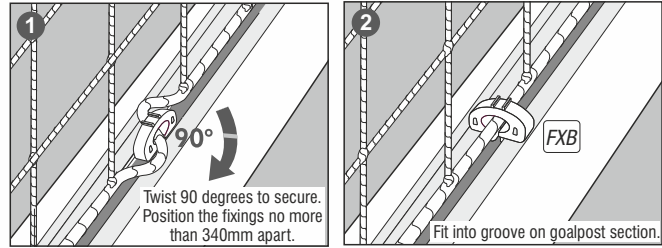

REMOVABLE TRANSPORTER WHEELS AVAILABLE

Not included - See over or visit itsagoal.net



Visit our YouTube site for assembly videos : www.youtube.com/user/Footballgoalposts

European & USA Patent GB 2423260

WORLDWIDE © COPYRIGHT 2001 ITSA GOAL POSTS LTD. ALL RIGHTS RESERVED A REGISTERED DESIGN WE RESERVE THE RIGHTS TO AMEND THE SPECIFICATIONS OF OUR SOCCER PRODUCTS IN THE INTEREST OF CONTINUED DEVELOPMENT. YOUR PRODUCT THEREFORE MAY DIFFER LIGHTLY TO THOSE ILLUSTRATED. E&OE

Lockable aluminium folding patented goal posts that are easy to move around use and store. Crossbar corners are welded both internally and externally to ensure they will stand up to the most rigorous conditions. The corners will not expand apart as with other goals as expansion is carried through the corner to lift the crossbar slightly and then when contracting gravity will take over. Oil and clean the lock to ensure the key is working well at all times. If a key breaks inside the lock a local locksmith will be able to remove it with a special pick. Spare keys are locks are always available. At the end of the season when the goals are not in use check all welds to ensure they have not become damaged. Check periodically through the season that the goals have not been damaged especially if they are left up in areas prone to vandalism. When installing your goals take your time and do a good job to ensure the best results and performance. The installation guides need to be read carefully prior to fixing. I can be contacted at any time on 07974745768 if you need any advice or help. To protect the life of your paintwork we suggest that 50mm wide plastic stretch tape be wrapped around the base of the posts about 600mm up from the ground to protect the paintwork from goal keepers kicking the foot of the posts to clean boots. This tape can be purchased from our web site or any local DIY store and should be renewed as and when required. It is much better however if you can ask all visiting and home goal keepers not to kick the posts. A thorough inspection each year and when goals are installed should be carried out and recorded. A goal post maintenance sheet is available to be downloaded from our web site www.itsagoal.net. Problems should be recorded, noted down and acted upon straight away. **DO NOT WALK OR STAND UNDER THE CROSSBAR WHEN MOVING OR STORING THE GOALS - DO NOT USE THE GOALS IF THEY ARE DAMAGED IN ANY WAY - TO DO SO WOULD WEAKEN THE STRUCTURE - THEY MUST BE REPAIRED BEFORE BEING BROUGHT BACK INTO USE. NEVER USE DAMAGED GOAL POSTS. Goals need to be treated and handled with care and they will then last longer and will perform better.** Any paint chips need to be repaired as soon as possible. Rub down with emery paper to form a smooth surface down to bear metal and apply a good quality aluminium primer undercoat and then a top coat to seal the affected area. Any areas left untreated will allow water to penetrate between the powder coat finish and the base metal and if left unchecked the paint work will start to peel away. Any local DIY store will supply what you need. If you treat the goalposts with respect and maintain them properly they will perform year after year.

Multi-surface anchors
Multi-surface anchors are designed to secure the freestanding goalposts to normal grass surface pitches (to 1100Newtons forward pull test). On a grass surface use the ground pegs provided in conjunction with the multi-surface anchors. If ground is softer then more ground anchors can be used to spread the load or longer pegs can be inserted. The safety ground pegs can also be used to retain your net if rear ground frames are not used with the folding goal. Always angle the pegs as shown on the fitting instructions. To remove stubborn pegs use another peg to lift out do not pull out with the anchor itself or it may damage the securing cross holding the peg in place. This is strong system designed to twist under stress and will not easily be damaged. If you are planning to anchor your goal post on tarmac the fixing positions for the multi-surface anchors need to be secure. We advise :-
1. Dig holes in your tarmac (to sizes specified in fitting instructions).
2. Fill holes with concrete, and drill two 14mm holes 12cm apart and 70mm depth.
3. Position goal and multi-surface anchors and use a suitable 10mm concrete bolt instead of the safety grass pegs. For other surfaces such as wooden sports hall floors wood screws in our multi-surface anchor or counter balance weights can be used. The total weight to conform to the current standards for the goal post topple test can be calculated using the equation stated below.

Goalpost Nets
All our square mesh nets are made to the shape of the net. If you are putting nets up each week we recommend that you locate the top corners first and mark them using tape so that you can easily identify them each time. Folding goal posts however are designed to enable the net to be left on the goal frame in the non-play position to allow swift match day installation. Place the net over the frame and fit each end onto top stanchion by securing on each corner of the crossbar and uprights using twist and lock net fixings. We recommend only nets with 100mm x 100mm mesh be used with children, to cover head entrapment regulations. Nets with 120mm x 120mm mesh are acceptable for use by adults. Nets can be tied into a bundle and placed into a pillow case (not to damage washing machine) and washed at 40 degrees Celsius with normal washing powder to keep them in tip top condition. Be aware rabbits and rodents have been known to nibble at the base of nets. If nets are left outside we advise lifting from ground level. If you have this problem sprinkle pepper along the bottom of the net and this should help deter most wild animals.

Counter balance weight system
The ITSA GOAL posts counter balance weight system consists of two counter balance weights each weighing 11kgs fastened together, 22 kilos of counterweight spread over 500mm. The counter balance weight system is used on flat level playing surfaces or where multi-surface anchors can not be used i.e. sports halls, artificial grass pitches etc. The two connected weights together can be lifted on the frame and used externally. If anchoring your freestanding goalpost is not possible, the guidance and technical notes set out by the Football Association give clear instructions for the use of counter balance weights. If you are unsure what weight you are required to use on your freestanding goal posts, you can work out the weight needed by using the following procedure.
1 Measure the height of the crossbar, 2 Measure the length of the goal's side bars. 3 Divide the height by the length. Multiply the result by 112Kg and make a note of the answer. This is the total weight in kilograms that should stabilize the goal to safety standards.
Example: A Regulation Goal, 2.44m high with a 2.025m ground sideframe the calculation would be: 2.44 divided by 2.025 = 1.205 therefore 1.205 x 112Kg = the total weight required for this goal would be 135Kg (less the weight of the back ground bar).

OPTIONAL REMOVABLE WHEEL TRANSPORTERS

The goal side frames fold neatly under the crossbar and lock away after use with Barrel Lock.

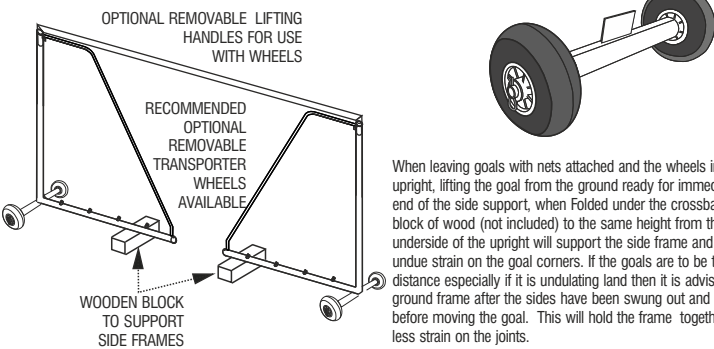

When leaving goals with nets attached and the wheels in place under the upright, lifting the goal from the ground ready for immediate use then the end of the side support, when folded under the crossbar needs support. A block of wood (not included) to the same height from the ground as to the underside of the upright will support the side frame and not put too much undue strain on the goal corners. If the goals are to be transported any distance especially if it is undulating land then it is advised to fit the rear ground frame after the sides have been swung out and locked in place before moving the goal. This will hold the frame together better and put less strain on the joints.

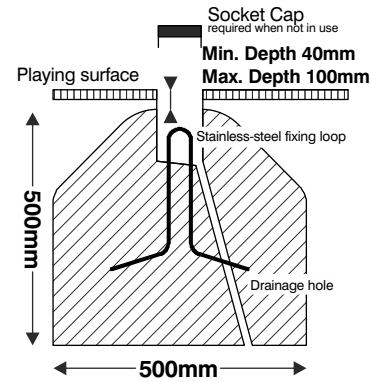
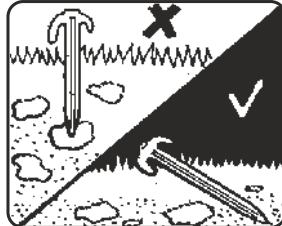
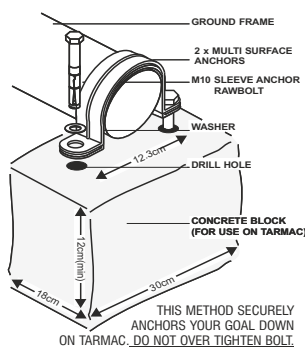
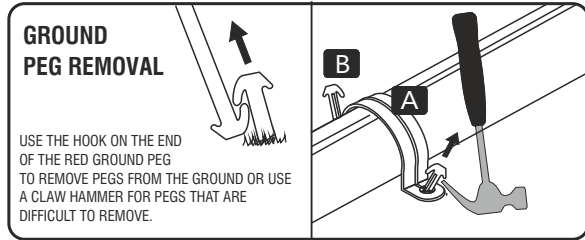

The Football Association Goals for Football Guidance Notes & Technical Details

Freestanding goals will only be safe if you stabilise them properly. Always use the accessories and anchors supplied for the purpose of anchoring a goal. The most reliable methods of stabilising freestanding goals are:

- attaching the back bar to permanent fixing points.
- using adequate weights attached to the goals backbar.
- adequate ground anchors

We strongly recommend you use one of these methods. The diagram on the right shows a typical freestanding goal foundation that will give a permanent pitch fixing.

VISIT www.itsagoal.net for up to date goal post safety information

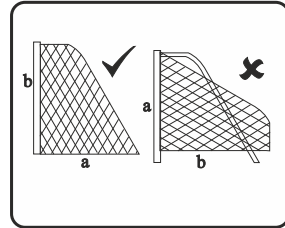

◀ **SQUARE MESH** Net is cut to shape. Simply throw over the frame and fit each end onto top stanchion by securing on each corner of crossbar.
NOTE: If your net does not fit the first time, you may be fitting it to the goal frame upside down i.e. that is to say the net from the crossbar to the floor (a) is longer than the length of the net to the bottom of the upright (b).

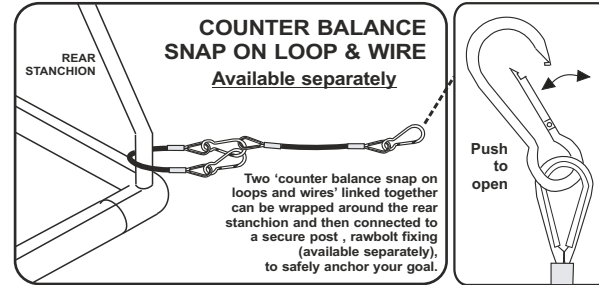

COUNTER BALANCE WEIGHT - OPTIONAL EXTRA

STEEL COUNTER BALANCE WEIGHTS
For use indoors or on artificial surfaces are available separately.

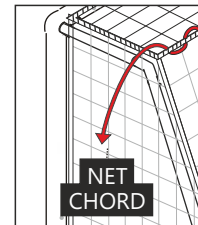

To help define the roof of the net. Tie the cord to one side and pull the net chord and wrap neatly around the stanchion section.
If you are regularly attaching or detaching the net then apply colored tape to the roof edges to help identify the roof area.

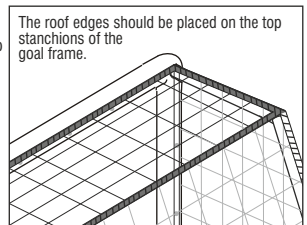

Test each goal post before use to satisfy yourself that you have enough counter balance weights attached to the goal to prevent toppling.

Chain and cable attachments Whatever method is used to stabilize a goal, any attachment chain or a wire cable between the goal and the weight, anchor, eye bolt or other fixing point should be as short as possible and not allow the back bar to lift more than 50 mm.

Care and Maintenance

- NEVER use our goalposts without securing locks or correct fittings or in non conforming ground sockets.
- DAMAGED COMPONENTS requested under guarantee must be returned for inspection. Failure to follow the warnings, assembly and fitting instructions contained in this document may invalidate your guarantee.

IT IS ADVISABLE IN ANY CONTACT SPORT TO TAKE OUT THE RELEVANT INSURANCES TO COVER ALL UNFORESEEABLE CIRCUMSTANCES. IT IS ADVISABLE TO CHECK YOUR GOALS WEEKLY AND UNDERTAKE ANY MAINTENANCE, CHECK PAINTWORK, CHECK NETTING, MAKES SURE ANY LOCKS OR BOLTS ARE IN PLACE, ENSURE THE FRAME IS ASSEMBLED IN ACCORDANCE WITH THE FITTING INSTRUCTIONS BEFORE EACH GAME. ANY NEW PEOPLE USING THE GOALS SHOULD BE PROVIDED WITH THIS LEAFLET AND EXTRA FITTING INSTRUCTIONS ARE AVAILABLE FROM www.itsagoal.net.

If the text is too small to read a larger easier to read copy is available upon request.

European & USA Patent GB 2423260
Registered Design 5000197 5000198 5000199

For video demonstrations visit :
www.youtube.com/Footballgoalspots



SPARE PARTS
TEL: 0114 24 34 200

Goalpost Slot Net Fixing

A net fixing that works on most aluminum goalposts that have a slot on the rear of the posts. This net fixing can be left in place in the slot on the goal extrusion or can be twisted out and left attached in position on the net.

To attached the net turn the net fixing upside down and lay it into the slot with the opening facing up. Do this with goal post extrusion laid on the ground. The two lugs on the top of the fixing will hold the fixing clip firmly in the goalpost slot upside down to enable the net to be pushed through the opening on the back of the fixing.

This is a unique design feature that makes it easier to insert the net inside the fixing compared to other similar types of net fittings. Much easier to fit than other similar net fixings.

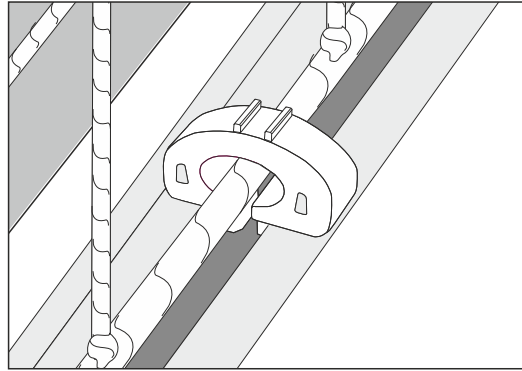

Fitting Instructions

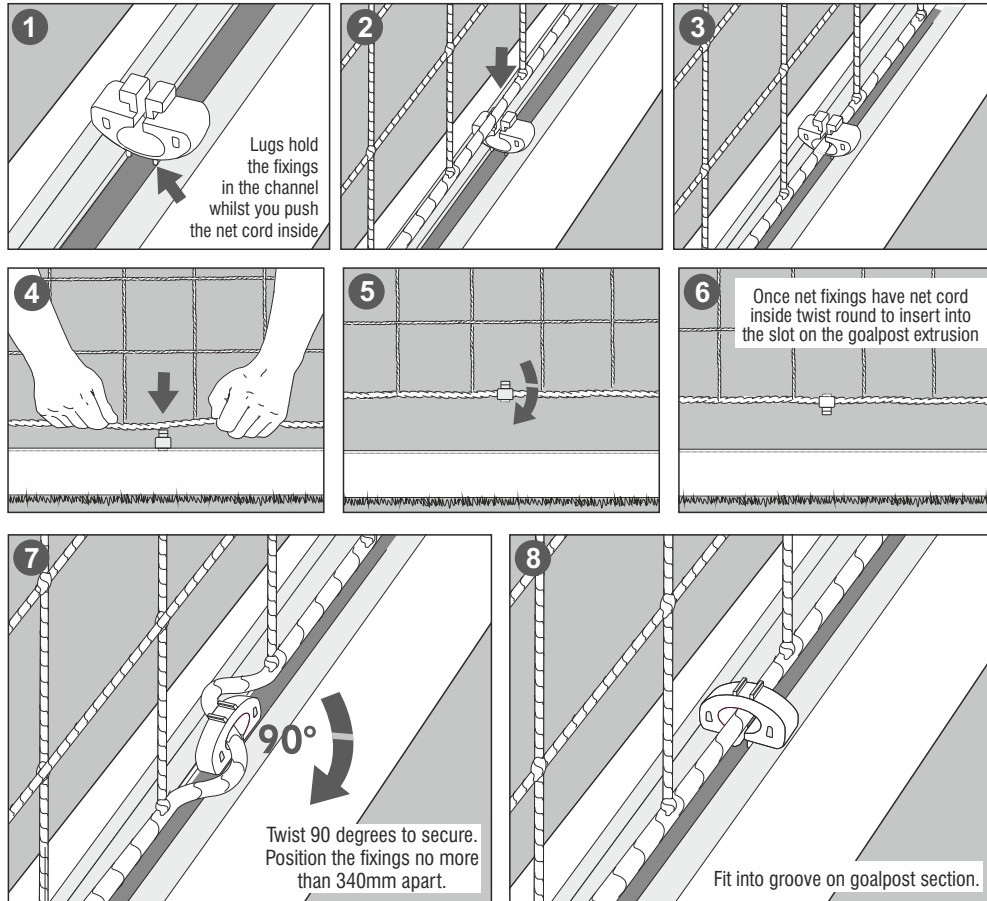

Quick Release Net Fixing

Slide the net fixings into the slot on the rear of the aluminum goalpost extrusion and twist ninety degrees to secure. Position the fixings not more than 340mm apart to conform to the latest goalpost safety standards. These fixings will fit into most aluminum goalposts with rear slots. The recessed net fixing is designed to be left in position on the goalposts and nets are simply slotted into the middle of the clip and rotated ninety degrees to hold the net in place. To remove the net just twist sideways ninety degrees and lift out. Fast easy quick release net fitting.

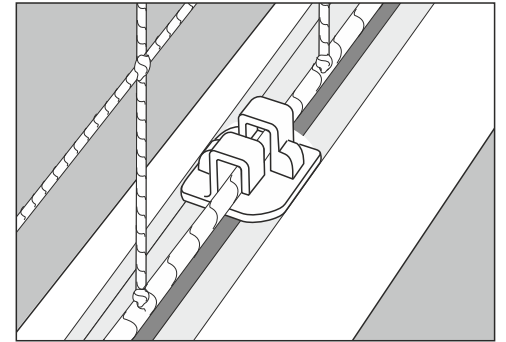

Fitting Instructions

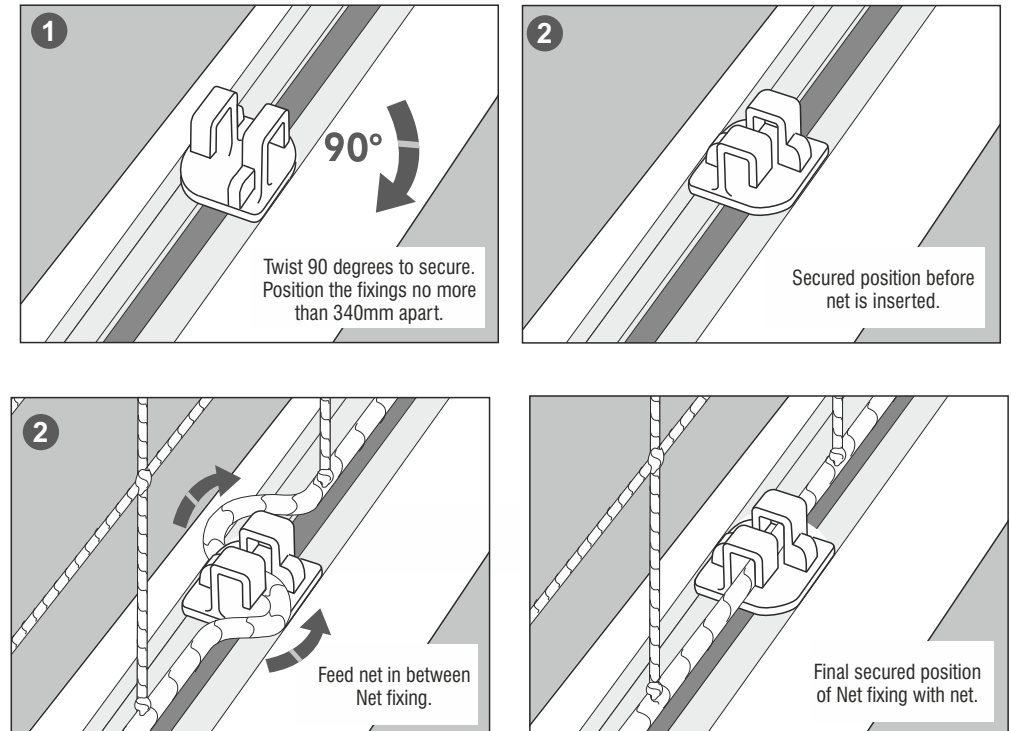

Note: If the net is to be permanently attached to the goal we offer a different Slot fittings, visit itsagoal.net for more information.

Folding Goal posts – Elliptical

Football Goalposts must at all times be used in accordance with the fitting instructions provided. When freestanding moveable goalposts are being positioned prior to a game children should not be allowed to use the goalposts until they are secure and anchored safely. Never position the goalpost and then go for the second goal before first making sure the first goal is securely anchored down.

Goalpost should be checked regularly and must be stored away safely as per instructions when not in use. This care and Maintenance information follows our own risk assessments and those of the Football Association Guidance Notes of 'best practice' to help ensure goals are safe. Sufficient counter balance weights or anchors must be attached to the goal at all times if it is left in its play position. When stored against a wall the goal frames MUST be secured on suitable brackets. If brackets are not available they should be stored flat face down on the ground. They should never at any time be lent against a wall unsecured. All Heavier free standing goal frames above 45 kilos in weight require additional care and attention when used around children.

The elliptical Foldaway goal was designed specifically with transportation and storage in mind. The goal is designed to be used on a grass with multi-surface anchors or on artificial grass with counter balance weights. Permanent anchor points can also be used to secure the goal in a fixed and permanent match position.

Note:- LARGER GOALPOSTS MUST BE MOVED WITH REAR GROUND FRAME ATTACHED

Goal post assembly

To avoid damage when assembling the goal follow these guidelines:

1. A competent adult should assemble the FOLDING GOAL and follow the fitting instructions provided. Individuals taking over future use of the goal posts should be instructed on the safe usage of the goal posts, how they are used in play, whilst being moved around and when in storage. Copies of goalpost fitting instructions can be attained on the website (www.itsagoal.net) for any new users of the goal posts.
2. Always observe and Follow the warning labels attached to the goal. During the life of any goalposts warning labels may become worn and these should be replaced. Goalpost spares including warning labels are readily available from ITSA Goal.
3. Always fold out the side frames on a flat section of ground and return back to a flat area when folding sides under crossbar after use. (Ideally a boarded area by your container or store)
4. Assemble the goals on a flat surface, if it is not flat the bolt holes may not line up correctly.

Goal post frame

If the folding goals are to be moved frequently any distance we recommend using wheels or dollies and adding the optional a back bar. Never allow one person to drag the goals along the ground as this will damage the corners and may twist the connectors and jam the locks in place making them difficult to remove after use. Prolonged misuse like this will permanently damage the goal frame.(see Fig 2)

1. NEVER use net stanchion supports to lift or drag the goal. This may cause the stanchions to bend and deform. Net supports are designed to support goal nets not people swinging on them.
2. Ensure you have an adequate number of physically fit and capable adults available when moving goalposts. Never allow children to move goalposts or play with the goalposts whilst they are being positioned for a game.
3. It is advisable not to drag the goal across the ground as this may damage the goal and playing surface. Lift the goal and carry with upright in one hand and side ground frame in the other (two people) or lift from the rear and pull when wheels are attached at the front (one person can then move the goal frame)
4. Do not place fingers at the top of the upright (inside the void created by the upright being oval in shape) when side frames are rotating.
5. ALWAYS lock the side frames in position when in play.
- 6 We would recommend Pneumatic wheels to move you goal on wet muddy surfaces and smaller hard wheels be used on artificial grass.

Goal with sides folded out for Use

Goal posts must NEVER be left up if unsupervised. Side frames must be locked during use to prevent the sides from swinging about which will make the goalpost unstable.

The folding Goal frame must be anchored immediately the side frames have been locked in the play position. NEVER walk away from the assembled goal frame until it is securely anchored.

NEVER allow anyone under any circumstance to climb or swing on the crossbar prior to the goal being anchored. Discourage this activity of swinging on crossbars at all times at your football club. It is a very common practice with young children but highly dangerous (see goalpost safety section on our web site)

DO NOT use any components, nets or parts if they are damaged or broken. Goal post Repairs & spare parts are readily available from our web site. Do not tamper with Goalposts.

The folding goalpost is not designed to be dragged as this can weaken and damage the corners of the goal frame. Always move the goalposts with sides folded out in the play position as shown on the fitting instructions.

The folding goal can be moved easily by one person with wheels. (See moving the goalposts on www.soccertackle.com web site) We recommend Goals transporter dollies for moving larger folding goalposts.

Goal with sides folded under crossbar for storage

Do not move goalposts with sides locked underneath the crossbar, for play fold out into the play position before moving if at all possible. The goalpost can however be moved in the none play position (side frames under crossbar) in certain tight access locations however it is important that individuals walk on the side the wind is blowing to prevent the frame blowing over onto them if a sudden gust happens ; however, it is not advisable to move the goals in extreme windy conditions.

When removing the goal post from the playing surface ensure that all fittings are packed away and that non are left on the pitch.

NEVER leave the goal post frame with sides folded under the crossbar and lent against a building or wall without first securing the goal post from toppling forward.

When folding the side frames back under the crossbar do it on a flat area.

Locks & Keys Do not force the key. A gentle movement of the side frame outwards past the ninety degree position) as you turn the key helps push the lock out after use. We suggest that furniture polish be applied to the lock housing and the corners to make movement of the parts easier.

If the key breaks in the lock and you do not have enough of the key exposed to pull it out then we advise to turn the upright around and tap the outside of the post with a rubber mallet and gravity should see the key drop out or sufficiently down from the lock to pull out with pliers.

Replacement and spare keys are readily available.

As these are the only locking secure side frames on any folding goal it is important to tell everyone using the folding goals that they are locked and do not just push in and out like other less stable folding goalposts. We have had volunteers actually push the side frames with the locks secured until they broke them as they had never seen locking frames only loose ones that swung about. Explain to all users how the goals work and the safety benefits they offer.

Moving the heavier elliptical goal

In order to move the Elliptical Foldaway goal ideally wheel attachments should be attached. If moved manually it should be lifted and carried fully assembled Carried with rear ground frame attached with left hand on upright and right hand on side frame (and vice-verse at the other side of the goalpost) as set out above. Goals must be fully assembled ideally when moving the goals.

please take note that additional measures need to be taken into account when moving this goal.

1. When moving the goal ensure that you NEVER have anyone walking directly behind in the path of the goalpost frame or underneath the frame.
2. Freestanding goalposts should NEVER be moved without an adequate number of physically fit and capable people who have been fully trained to use proper lifting techniques. A full size goal should never be manually moved using fewer than four adults or two adults with wheels or dollies.
3. Goalpost Wheels should be of a type suitable for the surface in which it will aid the goal to move across. Hard wheels are designed for firm or indoor surfaces while pneumatic wheels are for soft ground.

