









**STADIUM
SOCKETED****24' X 8' ELLIPTICAL ALUMINIUM 120X100MM SOCKETED GOAL****FITTING
INSTRUCTION****tsaGoal**
www.itsagoal.net

TEL: 0114 24 34 200



COMPONENTS



A	CHROME BARREL LOCK & KEY	x2	
B	GROUND SOCKET	x2	
B1	SOCKET BOLT 45mm THREAD LENGTH	x2	 8mm
FXB	GOALPOST SLOT NET FIXINGS	x50	
C1	CHROME BARREL LOCK & KEY	x1	

POST SECTIONS



H	CROSSBAR SECTION with INSERT 120mm x 100mm Diameter (Elliptical)	x1	
H1	CROSSBAR SECTION	x1	
I	UPRIGHT SECTION	x2	

OPTIONAL ITEMS

NET SUPPORT SUPPLIED IF PURCHASED WITH GOAL			
DS	REMOVABLE 'D' SUPPORT	x2	
J	M8 WINGNUT AND HEX SCREW -	x4	 8mm

SOCKET CAP SUPPLIED IF PURCHASED WITH GOAL			
CAP	OVAL LOCKING SOCKET CAP	x2	
KEY	HEAVY DUTY OVAL LOCKING	x2	
KEY	OVAL SOCKET CAP KEY	x1	

NET SUPPLIED IF PURCHASED WITH GOAL			
NET	GOAL NET	x1	

ACCESSORIES SUPPLIED IF PURCHASED WITH GOAL			
GP	GROUND PEG	x40	
	NET RETAINER - ALLOY	x1	
	NET RETAINER - STEEL	x1	

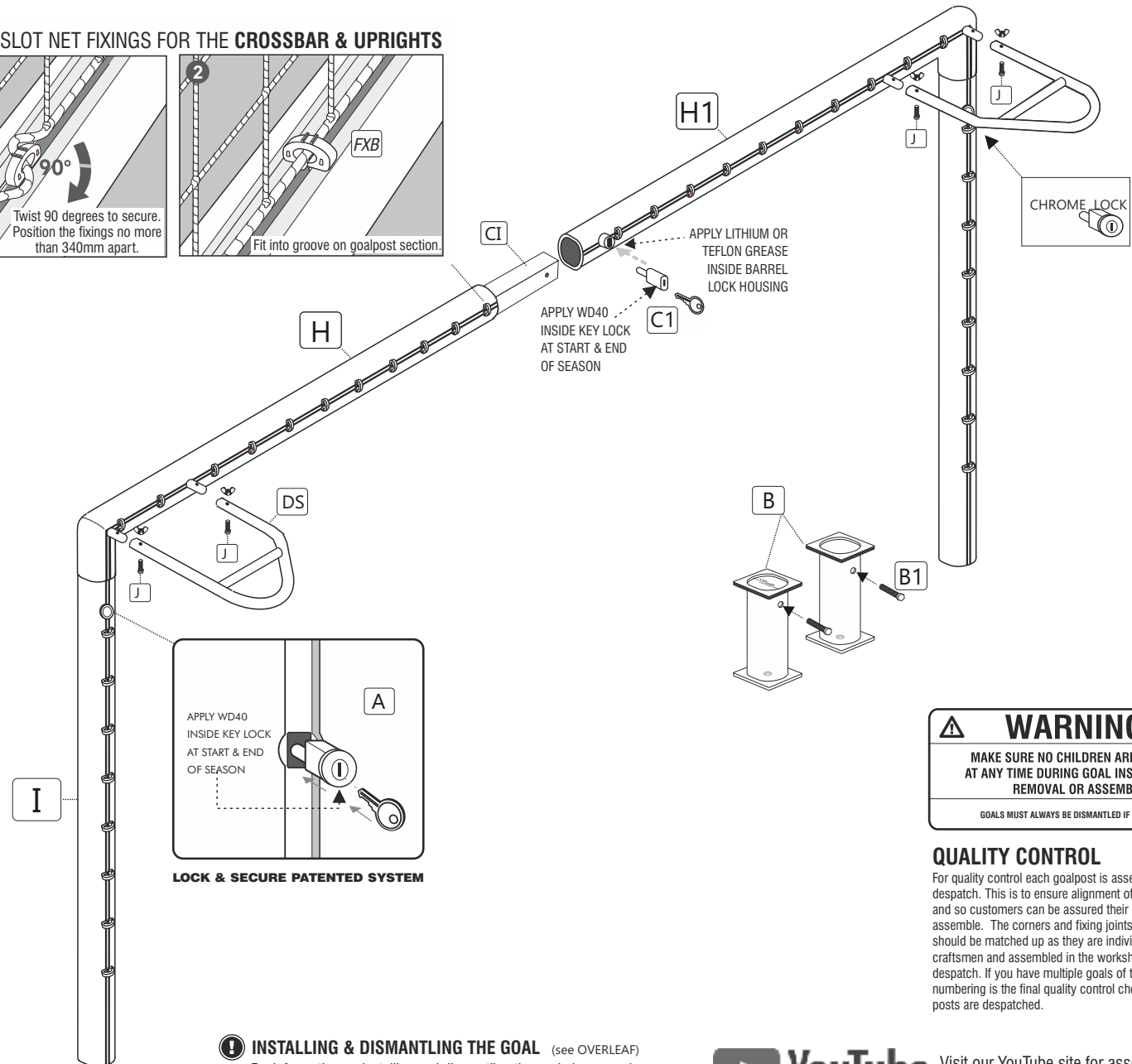
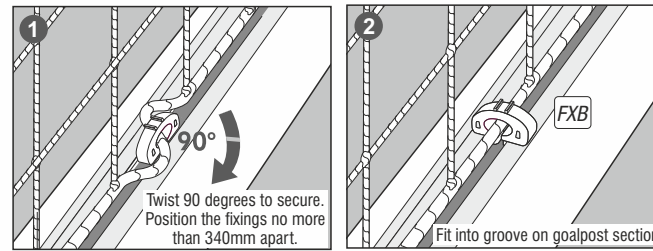
TWO SECTION CROSSBAR FOR STORAGE**GOALPOST SLOT NET FIXINGS FOR THE CROSSBAR & UPRIGHTS**

WARNING

MAKE SURE NO CHILDREN ARE PRESENT AT ANY TIME DURING GOAL INSTALLATION, REMOVAL OR ASSEMBLY.

GOALS MUST ALWAYS BE DISMANTLED IF NOT IN USE.

QUALITY CONTROL

For quality control each goalpost is assembled before despatch. This is to ensure alignment of fixing positions and so customers can be assured their goalpost will assemble. The corners and fixing joints are marked and should be matched up as they are individually made by craftsmen and assembled in the workshop before despatch. If you have multiple goals of the same type the numbering is the final quality control check before goal posts are despatched.

INSTALLING & DISMANTLING THE GOAL (see OVERLEAF)
For information on installing and dismantling the goal please read and follow the instructions on the other side of the page.

YouTube Visit our YouTube site for assembly videos :
www.youtube.com/user/Footballgoalposts

GROUND SOCKET *Installation diagram*

- 1 Upright
- 2 Sport Surface
- 3 Concrete Block
- 4 Ground Socket
- 5 Drainage Hole
- 6. Socket Bolt
- 7. Pea Gravel

Note 'Socket bolt' must be inserted to prevent ingress of soil into ground socket. Put a dab of grease on it and insert the screw into the hole and just leave it in place. At any time in the future it can be locked'.

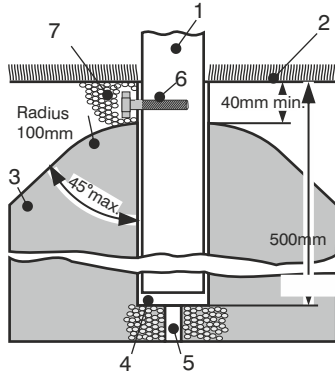

Goalpost Slot Net Fixing *Fitting Instructions*

A net fixing that works on most aluminum goalposts that have a slot on the rear of the posts. This net fixing can be left in place in the slot on the goal extrusion or can be twisted out and left attached in position on the net. To attached the net turn the net fixing upside down and lay it into the slot with the opening facing up. Do this with goal post extrusion laid on the ground. The two lugs on the top of the fixing will hold the fixing clip firmly in the goalpost slot upside down to enable the net to be pushed through the opening on the back of the fixing. This is a unique design feature that makes it easier to insert the net inside the fixing compared to other similar types of net fittings. Much easier to fit than other similar net fixings.

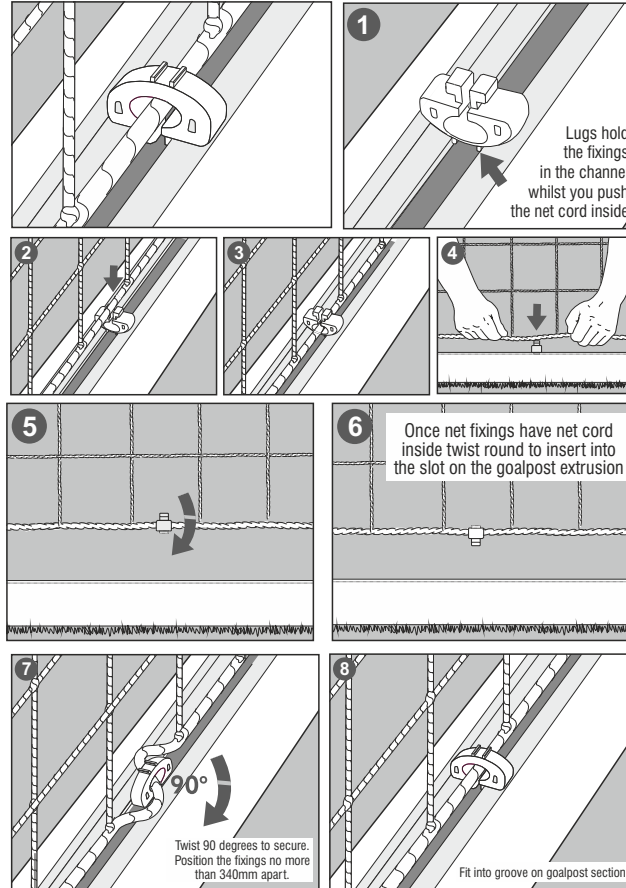

Net Fixing

- STEP 1** Attach the net to the net fixings on the crossbar and uprights. Fit the corners of the net to the top of each upright first then clip the net onto all other net fixings.
- STEP 2** Insert the red safety pegs (optional) to peg your net to the ground, fit corners first. Always insert pegs at an angle. When removing pegs use the back of a peg to take out. Do remove pegs by pulling nets.
- STEP 4** The net will have a net head cord. This is to lift the roof of the goal up behind the crossbar. Wrap the cord on the top of the net support on one side and tie off then go to the other side and pull tight and then wrap around the top support and tie off.

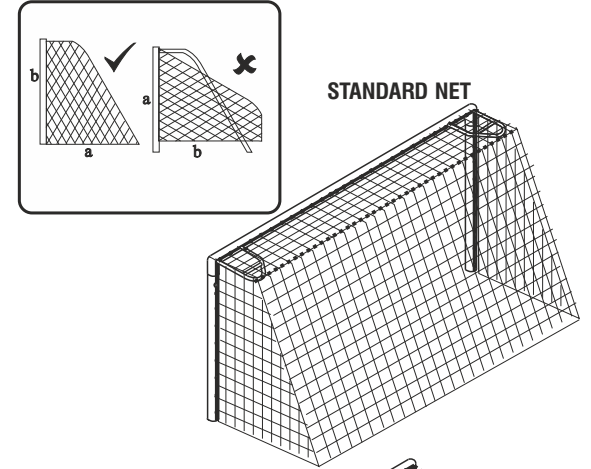

IMPORTANT- GROUND SOCKET

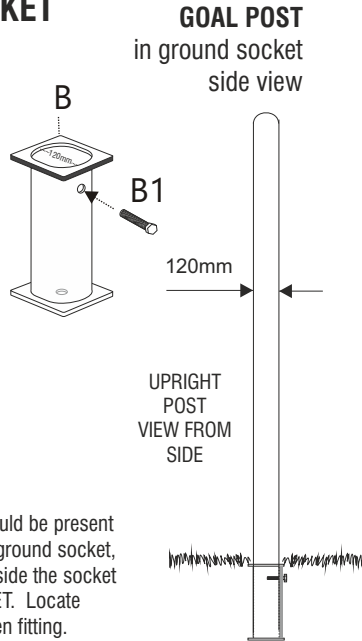
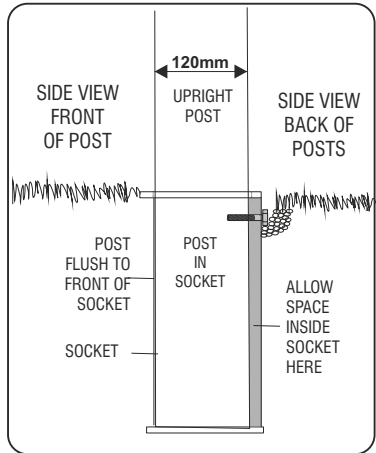

Grey area on diagram denotes the space that should be present once goal is inserted in socket. When fitting any ground socket, tape the top over to prevent concrete dropping inside the socket DURING INSTALLATION OF THE GROUND SOCKET. Locate Upright locking screw to the back of the post when fitting.

GOALPOST PROTECTOR TAPE
AVAILABLE SEPARATELY

Protects paintwork at the base of the upright.

TO PURCHASE VISIT www.soccertackle.com

LOCKABLE GROUND SOCKET CAPS
ARE AVAILABLE SEPARATELY

To cover and protect Ground Socket.

TO PURCHASE VISIT www.soccertackle.com



MADE IN ENGLAND www.itsagoal.net

For spare parts or additional products call the goal-line 0114 2434200 or visit our online supplier www.soccertackle.com

OPTIONAL NET RETAINER - designed to quickly lift nets for grass cutting.

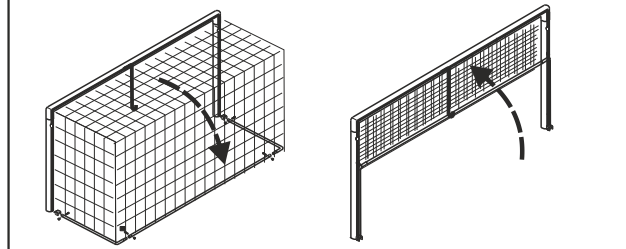

GROUND PEGS

LONGER GROUND PEGS ARE AVAILABLE SEPARATELY.

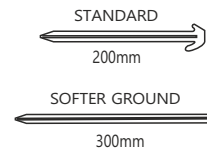

Longer pegs are to be used on sandy or Soft ground earth. **A risk assessment of soil conditions suitability should be carried out when anchors are to be used.**

