

COMPONENTS

A	CORNER BRACKET 4 HOLES	x4	
X	CORNER BRACKET 8 HOLES	x2	
B	NYLON SPIGOT	x4	
C	BLANKING CAP inserted in part X	x2	
D	MULTI-SURFACE ANCHOR	x6	
E	GROUND PEG	x12	
F	NYLON STANCHION ELBOW	x2	
G	NYLON LOWER BACK STANCHION CONNECTOR	x2	
J	M10 SOCKET DOME SCREW AND HEX DOME NUT - 75mm LONG	x12	
K	M8 HEX SCREW AND HEX DOME NUT - 50mm LONG	x8	
L	ARROW HEAD NET FIXING with attached LOCKING PIN	x30	
I	LARGE NET TIES - ground frame	x40	
M	SMALL STANCHION NET TIES	x12	
AK	HEX KEY FOR COMPONENT J	x1	
NET	GOAL NET 16' x 7'	x1	

ALUMINIUM FLAT-PACK 16' X 7' YOUTH GOAL (FLAT-PACK)

(16' x 7' Multi-Surface) - One section crossbar.

CARE & MAINTENANCE - see separate sheet supplied or visit www.itsagoal.net for additional copies. Our goalpost if used correctly will last many years. We do also offer a full spare part service and if your goals need refurbishment this can be arranged.



FITTING INSTRUCTION

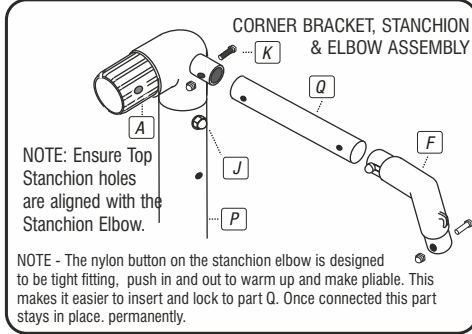

NOTE - The nylon button on the stanchion elbow is designed to be tight fitting, push in and out to warm up and make pliable. This makes it easier to insert and lock to part Q. Once connected this part stays in place, permanently.

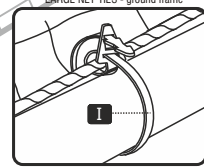
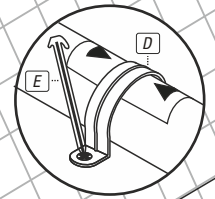
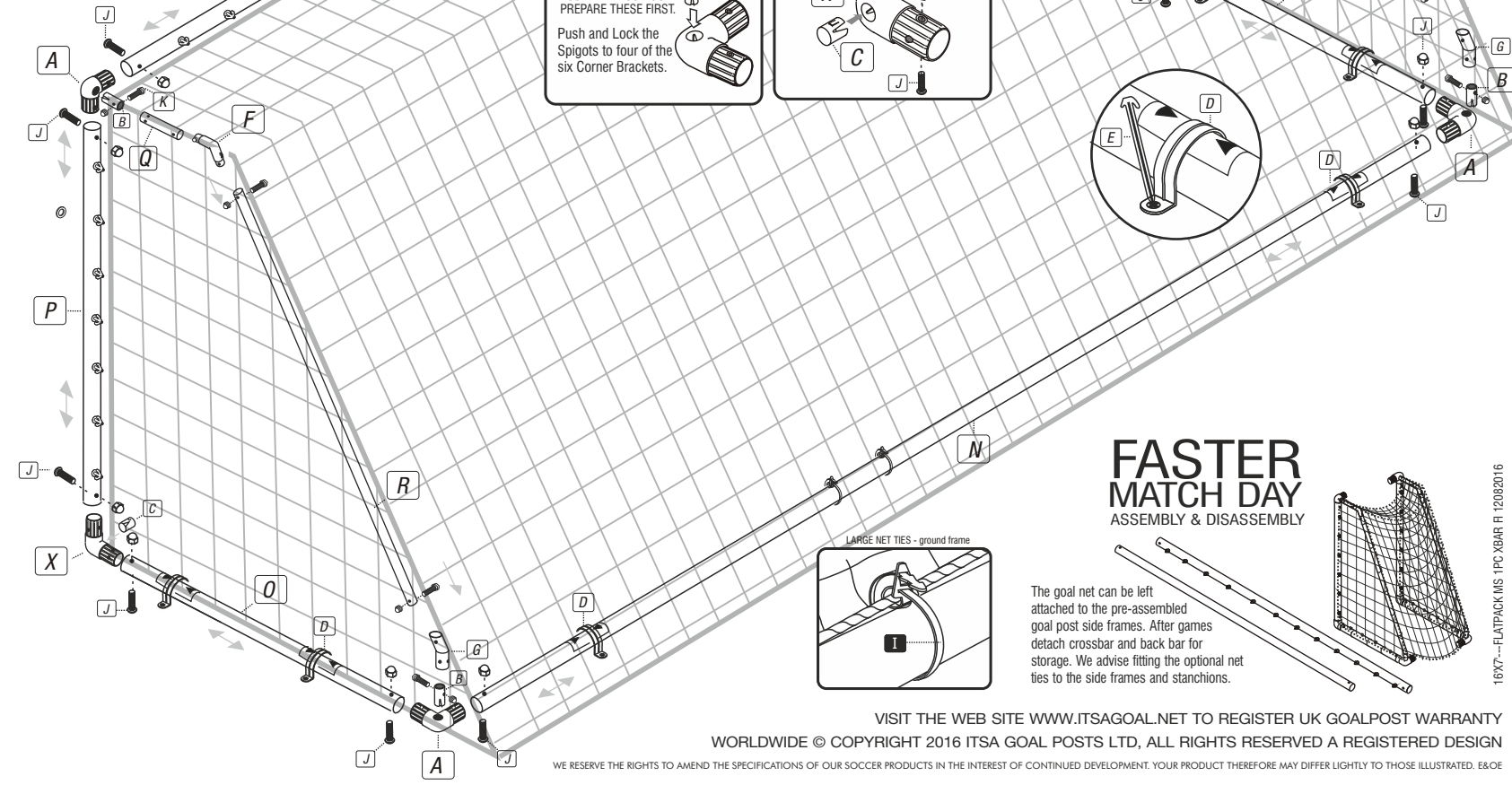
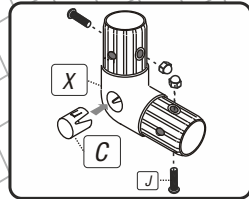
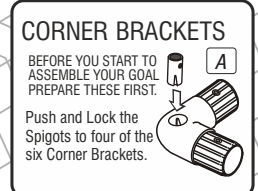

FASTER MATCH DAY ASSEMBLY & DISASSEMBLY

The goal net can be left attached to the pre-assembled goal post side frames. After games detach crossbar and back bar for storage. We advise fitting the optional net ties to the side frames and stanchions.

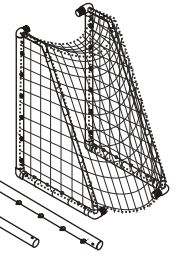

POST SECTIONS

Aluminium Sections and Tubes

M	CROSSBAR SECTION 4844mm LONG	x1	
N	BACKBAR SECTION 4844mm LONG	x1	
O	SIDEBAR SECTION 1726mm LONG	x2	
P	UPRIGHT SECTION 2031mm LONG	x2	
Q	TOP STANCHION TUBE 630mm LONG	x2	
R	BACK STANCHION TUBE 2232mm LONG	x2	

GOAL POSTS MUST BE ANCHORED AT ALL TIMES

Optional longer pegs are available for use on sandy ground. On grass, a risk assessment of soil and weather conditions suitability should be carried out when anchors or optional counter weights are to be used. TEL: 0114 2434200



Visit our YouTube site for assembly videos : www.youtube.com/user/Footballgoalposts

16X7-FLATPACK MS-1PC XBAR FH 12082016

STEP BY STEP NET FITTING

STEP 1

Open net and check the lengths of a and b correspond with the diagram below.

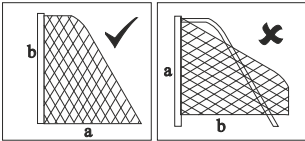

STEP 2

With the net the correct way round lift the net onto the goalpost frame. This is easier with two people.

NOTE: If your net does not fit the first time, you may be fitting it to the goal frame upside down i.e. that is to say the net from the crossbar to the floor (a) is longer than the length of the net to the bottom of the upright. (b)

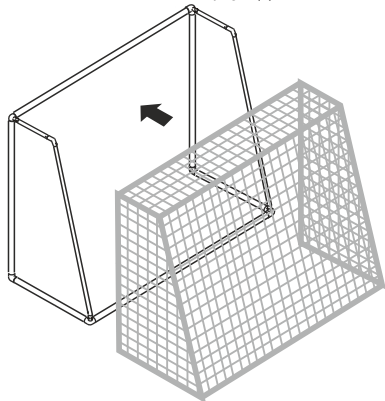

STEP 3

Attach the corners first, where the upright posts meets the crossbar as shown. Then attach the net to the post using the Arrow head net fixings on crossbar and uprights.

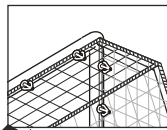

STEP 4

Using the large net ties tie the net to the ground side frame back ground frame.

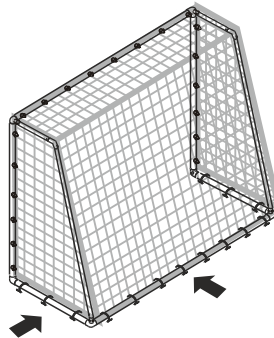

STEP 5

Using the small net ties attach the net down the back of the sloping back net supports as shown to the posts as shown.

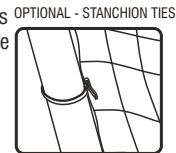

STEP 6

NET CORD - ROOF TO THE NET
To help define the roof of the net Tie the cord to one side and pull the net chord tight and wrap neatly down and around the stanchion section. If you are regularly attaching or detaching the net then apply coloured tape to the roof corners of net to help identify the roof area.

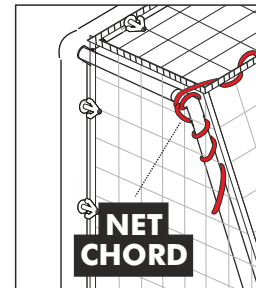

DO NOT THROW THE LOCKING PINS AWAY

ARROW HEAD NET FIXING



1 Insert Arrow Head into holes on posts

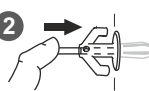

2 Push locking pin down centre of Arrow Head



3 Ensure locking pin is inserted fully in the posts

REMOVABLE NET TIES

ENSURE THAT YOU TIGHTEN THE NET TIE AROUND THE NET-CORD (no more than 340mm apart)

Ensure the teeth of the Net tie are facing you (see step 1). Loop the Net Tie around the Net Cord and slide the end into the horizontal slot and pull tight onto Net Cord (see step 1 - 2).

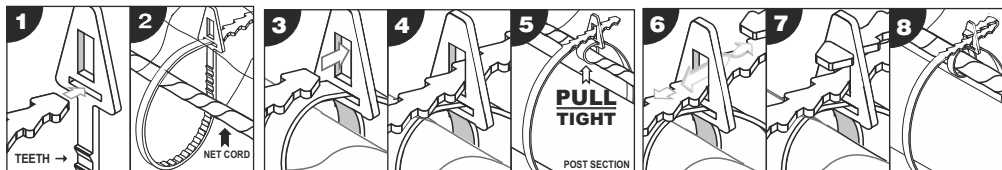

The vertical slot of the Net Tie is used to secure the net to the post. Loop the Net Tie around the post and insert through vertical slot and twist to lock. (steps 3 - 5). Any excess Net Tie can looped back into the vertical slot. This will also secure the net tie in a fixed position (steps 6 - 8). If Net Ties are to be removed after use then do not loop back into vertical slot.

Smaller net ties are ideal to attach nets to the side frames and the back net support tubes. These are useful when you leave your nets attached to the goals at all times.

ANCHORING YOUR GOAL

WARNING: Check the position of any underground services before using the ground anchors and pegs. We take no responsibility for any damage or injury caused in this manner.

HARD SURFACES: to prevent damage to goal or it's components, loosen soil with a steel pole and moisten with some water before inserting the ground anchors. Do not use the goal in sub zero temperatures.

ANCHORING YOUR GOAL ON GRASS - POSITION YOUR GOAL ON A LEVEL PLAYING SURFACE. PLACE THE MULTI-SURFACE ANCHOR OVER EACH SIDE OF THE GROUND FRAME (POSITIONS SHOWN) HAMMER THE PEGS THROUGH THE HOLES (DO NOT USE METAL HAMMERS USE RUBBER MALLETS) ON THE ANCHOR DOWN UNDER THE FRAME INTO THE GRASS ADDITIONAL ANCHORS OR LARGER PEGS CAN BE PURCHASED FOR USE ON SOFT GROUND OR SAND. THESE ANCHORS CAN BE USED FOR HARD SURFACES SUCH AS TARMAC WITH OPTIONAL BOLTS. ON HOT/SUNNY DAYS TARMACADAM SOFTENS AND THEREFORE TO ANCHOR YOUR GOAL PROPERLY YOU MUST:-

- 1 DIG HOLES IN YOUR TARMAC FILL HOLES WITH CONCRETE
 - 2 DRILL TWO 14MM HOLES 12CM APART AND 70MM DEPTH.
 - 3 POSITION GOAL AND ANCHOR, INSERT AND TIGHTEN BOLT.
- FOR OTHER SURFACES SUCH AS WOODEN SPORTS HALL FLOORS WOOD SCREWS (INSTEAD OF BOLTS) OR COUNTER BALANCE WEIGHTS CAN ALSO BE USED (SUPPLIED SEPARATELY).

For help contact www.itsagoal.net
Goalpost videos - <https://www.youtube.com/user/footballgoalposts>

SPARE PARTS TEL: 0114 24 34 200

WORLDWIDE © COPYRIGHT 2016 ITSA GOAL POSTS LTD.
ALL RIGHTS RESERVED A REGISTERED DESIGN

Longer pegs are to be used on sandy or Soft ground earth. A risk assessment of soil conditions suitability should be carried out when anchors are to be

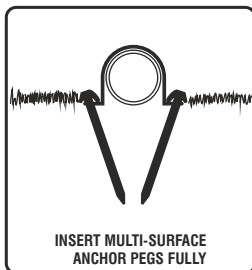
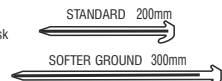

INSERT MULTI-SURFACE ANCHOR PEGS FULLY

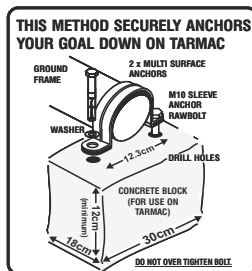

THIS METHOD SECURELY ANCHORS YOUR GOAL DOWN ON TARMAC

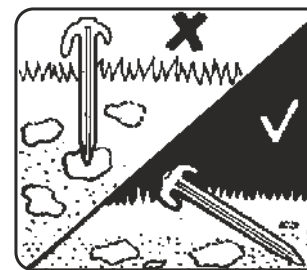
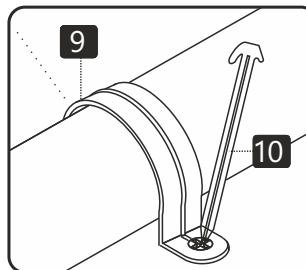

LONGER GROUND PEGS ARE AVAILABLE SEPARATELY.

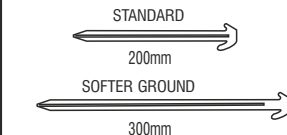

Longer pegs are to be used on sandy or Soft ground earth. A risk assessment of soil conditions suitability should be carried out when anchors are to be used.

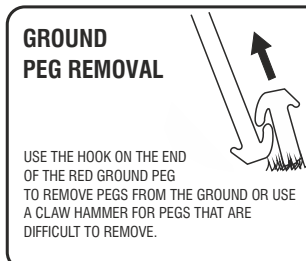

GROUND PEG REMOVAL

USE THE HOOK ON THE END OF THE RED GROUND PEG TO REMOVE PEGS FROM THE GROUND OR USE A CLAW HAMMER FOR PEGS THAT ARE DIFFICULT TO REMOVE.

