

COMPONENTS

A	CORNER BRACKET 4 HOLES	x4	
FB	FOLDING BRACKET	x2	
X	CORNER BRACKET UPRIGHT 8 HOLES	x2	
B	SPIGOT	x4	
C	BLANKING CAP	x2	
D	MULTI-SURFACE ANCHOR	x2	
E	GROUND PEG	x4	
F	STANCHION ELBOW	x2	
G	LOWER BACK STANCHION CONNECTOR	x2	
H	LARGE QUICK RELEASE BUTTON	x14	
I	SMALL QUICK RELEASE BUTTON	x8	
J	NET TIE	x26	
K	ARROW HEAD NET FIXING with attached LOCKING PIN	x10	
NET	GOAL NET 8' x 6'	x1	

POST SECTIONS

L	CROSSBAR SECTION 1726mm - 68mm Diameter	x1	
M	BACKBAR SECTION 1726mm - 68mm Diameter	x1	
N	SIDEBAR SECTION 865mm - 68mm Diameter	x2	
O	UPRIGHT SECTION 1205mm - 68mm Diameter	x2	
P	TOP STANCHION TUBE 239mm - 40mm Diameter	x2	
Q	BACK STANCHION TUBE 1265mm - 40mm Diameter	x2	

CARE & MAINTENANCE - see separate sheet supplied or visit www.itsagoal.net for additional copies. Our goalpost if used correctly will last many years. We do also offer a full spare part service and if your goals need refurbishment this can be arranged

6' X 4' FOLDING FASTSTARTQUICKGOAL®

One section crossbar.

FOR A FAST START - Lift the goal into position and unfold the side frames, click the back bar in, insert ground anchors and you're ready to start the game.

STORAGE

The goal can be folded flat for easier storage after games.

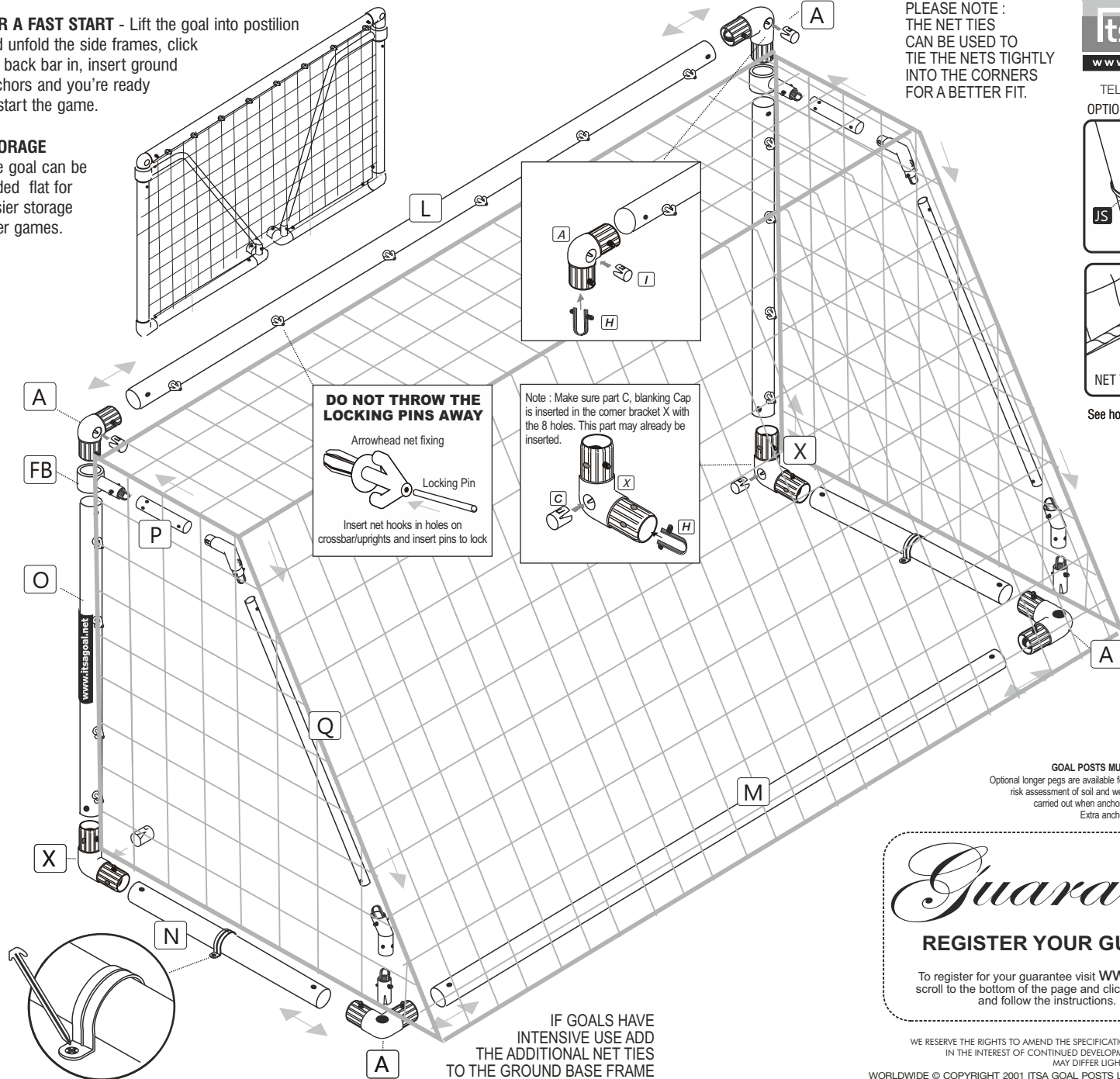

PLEASE NOTE :
THE NET TIES
CAN BE USED TO
TIE THE NETS TIGHTLY
INTO THE CORNERS
FOR A BETTER FIT.

FITTING INSTRUCTION



TEL: 0114 24 34 200

OPTIONAL - STANCHION TIES

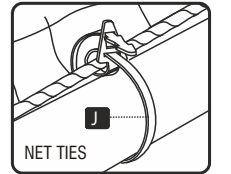
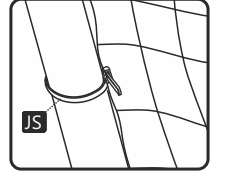

See how to fit the net overleaf

GOAL POSTS MUST BE ANCHORED AT ALL TIMES

Optional longer pegs are available for use on sandy ground. On grass, a risk assessment of soil and weather conditions suitability should be carried out when anchors or counter weights are to be used. Extra anchors are available TEL: 0114 2434200

Guarantee

REGISTER YOUR GUARANTEE

To register for your guarantee visit www.itsagoal.net scroll to the bottom of the page and click on the link 'Guarantee' and follow the instructions. Thank you.

IF GOALS HAVE INTENSIVE USE ADD THE ADDITIONAL NET TIES TO THE GROUND BASE FRAME

WE RESERVE THE RIGHTS TO AMEND THE SPECIFICATIONS OF OUR SOCCER PRODUCTS IN THE INTEREST OF CONTINUED DEVELOPMENT. YOUR PRODUCT THEREFORE MAY DIFFER SLIGHTLY TO THOSE ILLUSTRATED. E&OE WORLDWIDE © COPYRIGHT 2001 ITSA GOAL POSTS LTD, ALL RIGHTS RESERVED

STEP BY STEP ASSEMBLY

FOR EASIER ASSEMBLY Use a rubber mallet and also spray furniture polish inside posts. Do not use a metal hammer. Do not apply grease or vaseline.

STEP 1 Lay out POSTS and Components shown on page 1

CROSSBAR & BACKBAR 2422 mm
L M

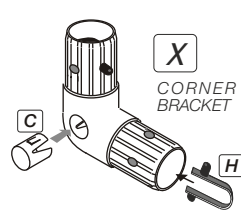
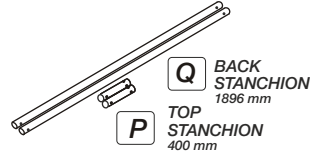
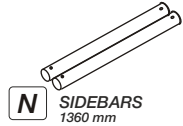
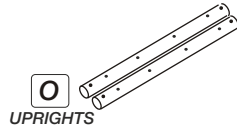
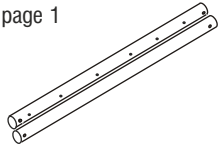

STEP 2

Insert Blanking Cap part C and insert Large Quick Release Button H (x2) into Corner Bracket X. (NOTE: Corner Bracket X is to be fitted into the upright posts and has 8 holes.)

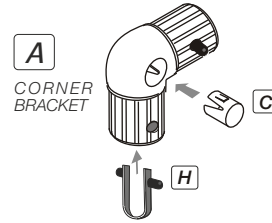

STEP 3

Insert Blanking Cap part C and insert Large Quick Release Button H (x2) into Corner Bracket A. (NOTE: Corner Bracket A has 4 holes.)

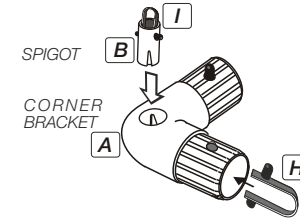

STEP 4

Insert Small Quick Release Black Button I into the Spigot B. Insert Spigot B and insert H (x2) into two of the Corner Bracket A. (NOTE: Corner Bracket A has 4 holes for locks)

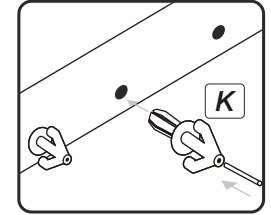

STEP 5

Insert Arrow Head Net Fixings K into Upright Posts and Crossbar. DO NOT THROW AWAY LOCKING PINS

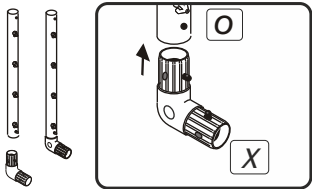

STEP 6

Insert Corner Brackets X into the upright posts O (uprights have logos on the side)

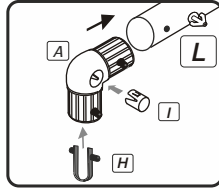

STEP 7

Insert Corner Brackets A into each end of the crossbar L

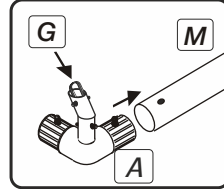

STEP 8

Insert Corner Brackets A into each end of the Backbar M

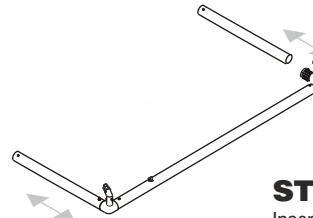

STEP 9

Attach Side bars N to the ground back bar by slotting into the corners brackets

STEP 10

Insert part I (locking button) into FB and connect Folding Bracket FB on the upright posts. Attach Uprights O to the Side bars N

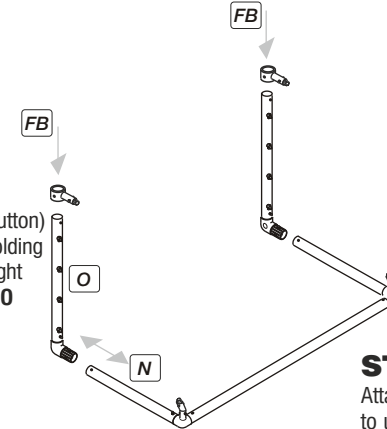

STEP 11

Attach Crossbar L to uprights O

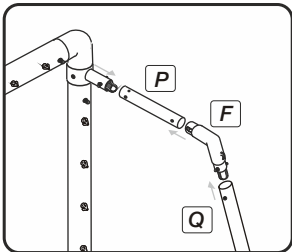

STEP 12

Join top tubes P to elbows F and back tubes Q and connect to the goalpost

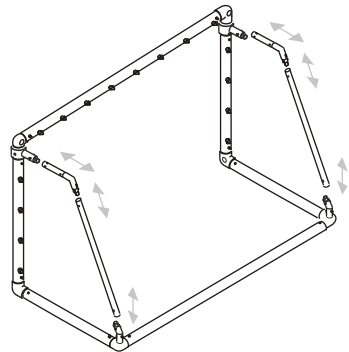

STEP 13

Attach Ground Anchors see details of use overleaf.

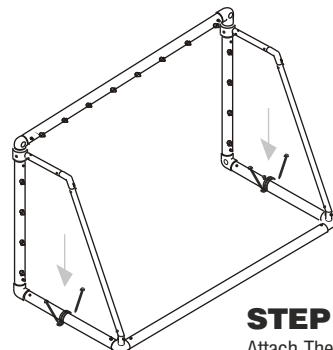

STEP 14

Attach The Net to the Net Fixings. Start with each corner

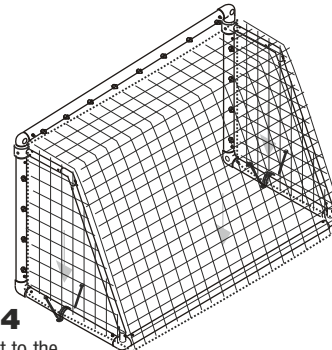

TIE A CORD BETWEEN THE TOP SUPPORT TUBES TO SUPPORT THE ROOF OF THE NET (THIS CAN BE LEFT TIED IN POSITION WHEN DISMANTLED)

OPTIONAL - Net ties are ideal to fit nets tightly to the side ground frames and stanchions. This is ideally when nets are left attached to the fully assembled side frames.

FASTSTART®QUICKGOAL

FOR A FAST START - Lift the goal into position and unfold the side frames, click the back bar in, insert ground anchors and you're ready to start the game.

STORAGE

The goal can be folded flat for easier storage after games.

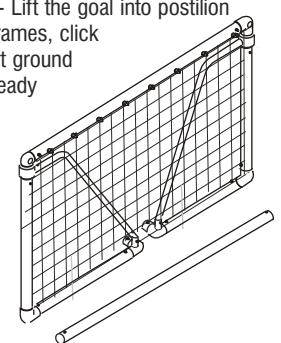

STEP BY STEP NET FITTING

STEP 1

Open net and check the lengths of a and b correspond with the diagram below.

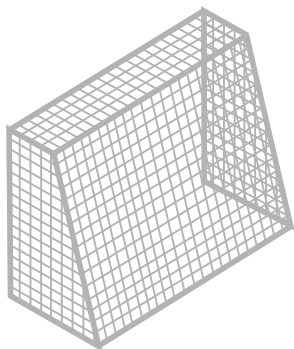
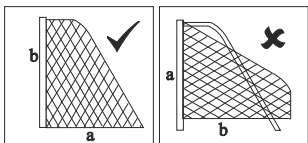

STEP 2

With the net the correct way round lift the net onto the goalpost frame. This is easier with two people.

NOTE: If your net does not fit the first time, you may be fitting it to the goal frame upside down i.e. that is to say the net from the crossbar to the floor (a) is longer than the length of the net to the bottom of the upright. (b)

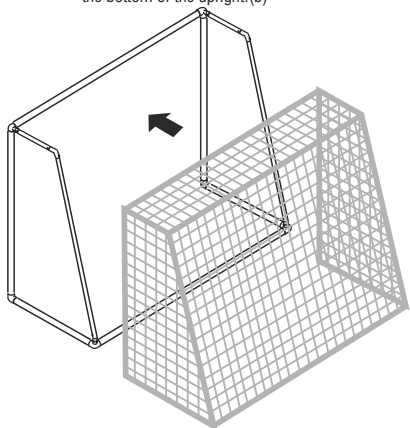

STEP 3

Attach the corners first, where the upright meets the crossbar as shown. Then attach the net to the post using the Arrow head net fixings on crossbar and uprights.

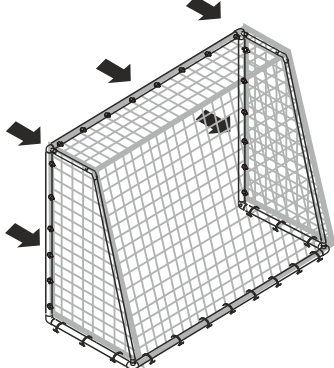
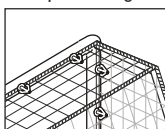

STEP 4

Using the large net ties tie the net to the ground side frame back ground frame.

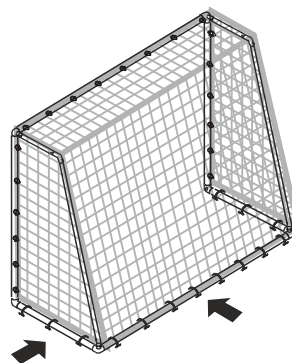

STEP 5

Using the small net ties attach the net down the back of the sloping back net supports as shown to the posts as shown.

OPTIONAL - STANCHION TIES

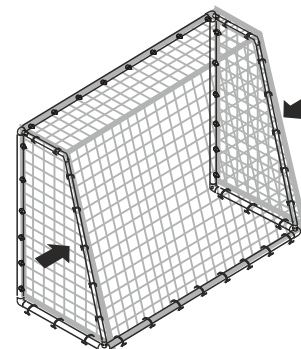
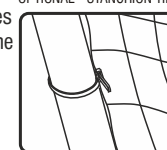

STEP 6

NET CORD - ROOF TO THE NET
To help define the roof of the net Tie the cord to one side and pull the net chord tight and wrap neatly down and around the stanchion section. If you are regularly attaching or detaching the net then apply coloured tape to the roof corners of net to help identify the roof area.

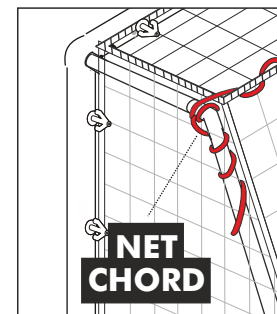

ANCHORING YOUR GOAL

WARNING: Check the position of any underground services before using the ground anchors and pegs. We take no responsibility for any damage or injury caused in this manner.

HARD SURFACES: to prevent damage to goal or it's components, loosen soil with a steel pole and moisten with some water before inserting the ground anchors. Do not use the goal in sub zero temperatures.

ANCHORING YOUR GOAL ON GRASS - POSITION YOUR GOAL ON A LEVEL PLAYING SURFACE. PLACE THE MULTI-SURFACE ANCHOR OVER EACH SIDE OF THE GROUND FRAME (POSITIONS SHOWN) HAMMER THE PEGS THROUGH THE HOLES (DO NOT USE METAL HAMMERS USE RUBBER MALLETS) ON THE ANCHOR DOWN UNDER THE FRAME INTO THE GRASS ADDITIONAL ANCHORS OR LARGER PEGS CAN BE PURCHASED FOR USE ON SOFT GROUND OR SAND. THESE ANCHORS CAN BE USED FOR HARD SURFACES SUCH AS TARMAC WITH OPTIONAL BOLTS. ON HOT/SUNNY DAYS TARMACADAM SOFTENS AND THEREFORE TO ANCHOR

YOUR GOAL PROPERLY YOU MUST:-

- 1 DIG HOLES IN YOUR TARMAC FILL HOLES WITH CONCRETE
- 2 DRILL TWO 14MM HOLES 12CM APART AND 70MM DEPTH.
- 3 POSITION GOAL AND ANCHOR, INSERT AND TIGHTEN BOLT.

FOR OTHER SURFACES SUCH AS WOODEN SPORTS HALL FLOORS WOOD SCREWS (INSTEAD OF BOLTS) OR COUNTER BALANCE WEIGHTS CAN ALSO BE USED (SUPPLIED SEPARATELY).

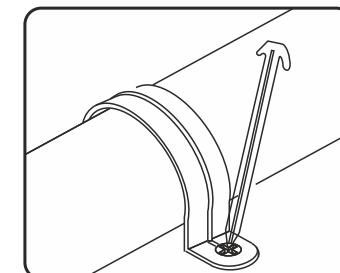
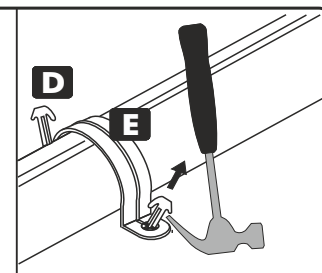
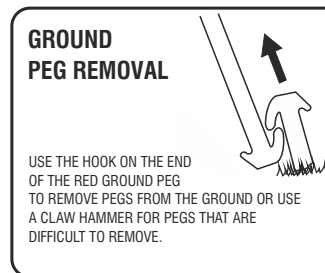
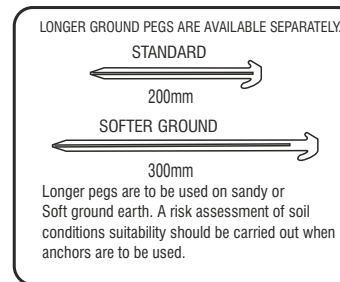
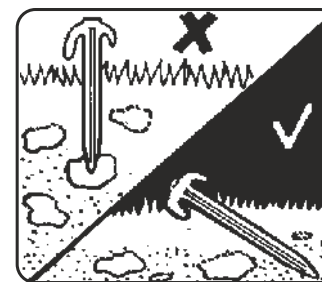
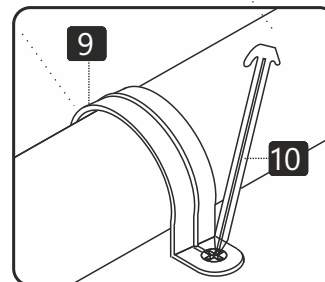
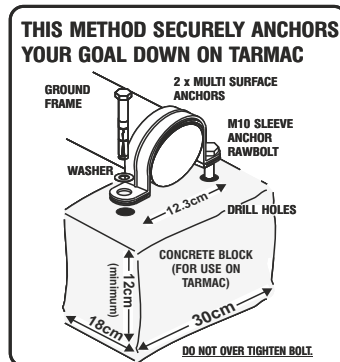
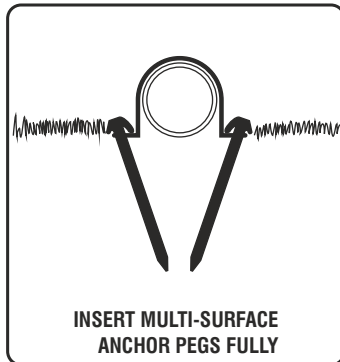

For help contact www.footiegoals.com
SPARE PARTS TEL: 0114 24 34 200

WORLDWIDE © COPYRIGHT 2016 ITSA GOAL POSTS LTD.
ALL RIGHTS RESERVED A REGISTERED DESIGN

DO NOT THROW THE PINS AWAY

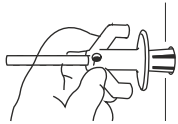

1

Insert Arrow Head into Holes on posts

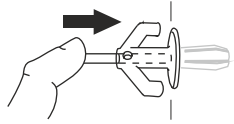

2

Push locking pin Down centre of Arrow Head

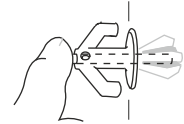

3

Ensure locking pin Is inserted Fully in the posts

At the end of the season nets can be tied into a bundle and placed into a pillow case (not to damage washing machine) and washed at 40 C0 with normal washing powder. The ground frame can be washed with hot soapy water. Any scuff marks on posts can be rubbed off with a light abrasive scouring pad.

WARNING: Check the position of any underground services before using the ground anchors and pegs. We take no responsibility for any damage or injury caused in this manner.

NEVER use the goals without the ground anchor system. In severe weather or windy conditions it is advisable to take your goal down as damage is not covered by the guarantee in such circumstances. If you find the nets are worn along the floor it may be rodents, by spreading pepper along the base frame rodents will be deterred. It is advisable in any contact sport to take out the relevant insurance's to cover against injury both from taking part, equipment and other unforeseeable circumstances. Crossbars will not be replaced within the guarantee period if broken by swinging or climbing or any other misuse.

DO NOT try to glue any damaged fixings. Plastic materials in this product vary and this may cause the plastic to break. Always replace any damaged components.

NET TIES

Ensure the teeth of the Net tie are facing you (see step 1). Loop the Net Tie around the Net Cord and slide the end into the horizontal slot and pull tight onto Net Cord (see step 1- 2).

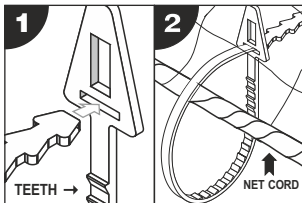

The vertical slot of the Net Tie is used to secure the net to the post. Loop the Net Tie around the post and insert through vertical slot and twist to lock. (steps 3 - 5).

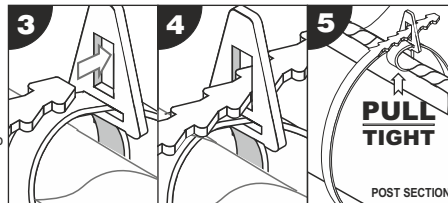

Any excess Net Tie can looped back into the vertical slot. This will also secure the net tie in a fixed position (steps 6 - 8). If Net Ties are to be removed after use then do not loop back into vertical slot.

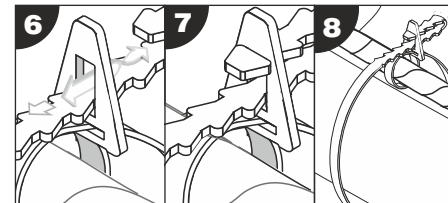

SQUARE MESH Net is cut to shape. Simply throw over the frame and fit each end onto top stanchion by securing on each corner of crossbar.
NOTE: If your net does not fit the first time, you may be fitting it to the goal frame upside down i.e. that is to say the net from the crossbar to the floor (a) is longer than the length of the net to the bottom of the upright. (b)

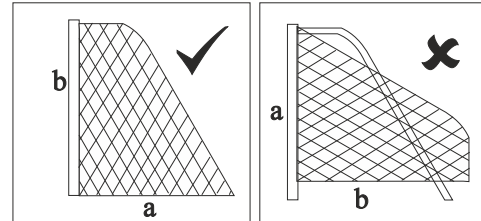

CORNER BRACKETS

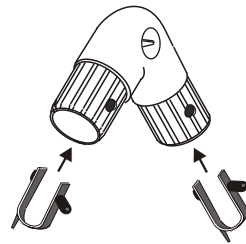

Push and Lock the Large Quick Release Buttons into the ends of the Corner Brackets.

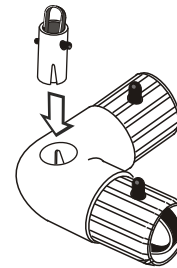

Push and Lock the spigots to two of the four Corner Brackets.

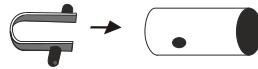

Push and Lock the Small Quick Release Buttons into the ends of the Spigots.

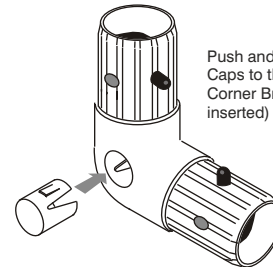

Push and Lock the Blanking Caps to the two remaining Corner Brackets. (already inserted)

We advise adult supervision during assembly and use. Observe and follow warning labels attached to goal. Do not use any components, nets or parts if they are damaged or broken. Spare parts and replacement nets are readily available. If others are to install your goal you should show them how to erect and dismantle the goal and hand them a copy of the fitting instruction. If you lose your instructions copies can be attained from our company website. To avoid damage when dismantling the goal follow these guidelines: it is advisable in extreme windy conditions to dismantle the goal and store away. Do not drop any heavy objects on ends of tubes. When dismantling the goal ensure that all fittings are packed away and that non are left on the playing surface. Warning goals must never be left up or used unless they are properly fitted with ground anchors with net attached and securely pegged down.

Do not use the goal in sub zero temperatures. warning labels should be replaced when worn and we recommend replacing them every two years - spare labels available. damaged components requested under guarantee must be returned for inspection. Failure to follow the warnings, fitting instructions contained in this document, may invalidate your guarantee. The company, its agents and representatives do not accept any product liability if used outside the EU. Use of the product in other countries outside the EU including the USA is not covered and appropriate insurance should be taken out by the user to cover for any eventuality. We reserve the rights to amend the specifications of our soccer products in the interest of continued development. Your product therefore may differ slightly to those illustrated. Not suitable for children under 36 months until assembled due to small parts.

NOTE : All plastic extrusions vary and therefore some tubes may be looser or tighter to connector fittings. If you want to increase the diameter of the fitting just wrap masking tape around the part that fits into the tube, twist as you insert the fitting and it will grab to the tube tight ...you can make tighter fits by adding more tape.

Guarantee

REGISTER YOUR GUARANTEE

To register for your guarantee visit www.itsagoal.net scroll to the bottom of the page and click on the link 'Guarantee' and follow the instructions. Thank you.



SPARE PARTS

TEL: 0114 24 34 200