









## COMPONENTS

- A** KEY x2 
- B** BRASS BARREL LOCK & KEY x2 
- C** GROUND SOCKET WITH PLASTIC CAP & BOLT x2 
- D** NYLON ARROW HEAD NET x48 

## STEEL POST SECTIONS

- E** CROSSBAR SECTION x1 
- F** UPRIGHT SECTION x2 

## NET SUPPORT SUPPLIED IF PURCHASED WITH GOAL

- G** REMOVABLE 'D' SUPPORT x2 
- H** M8 WINGNUT AND HEX SCREW - x4 

## NET SUPPLIED IF PURCHASED WITH GOAL

- NET** GOAL NET 24' X 8' x1 

ⓘ REMOVABLE 'D' SUPPORTS AND NET ARE OPTIONAL

## REMOVABLE 'D' SUPPORTS

ARE AVAILABLE SEPARATELY

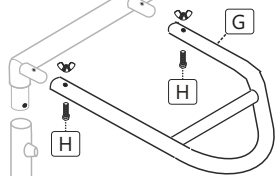

To hold and support the Net.

TO PURCHASE VISIT [www.soccertackle.com](http://www.soccertackle.com)

**STEEL**  
ANTI-VANDAL

# 24' X 8' ANTI-VANDAL GOAL

(24' x 8' Grass-Surface) - One section crossbar.

## ⚠ WARNING

MAKE SURE NO CHILDREN ARE PRESENT AT ANY TIME DURING GOAL INSTALLATION, REMOVAL OR ASSEMBLY.

GOALS MUST ALWAYS BE DISMANTLED IF NOT IN USE.

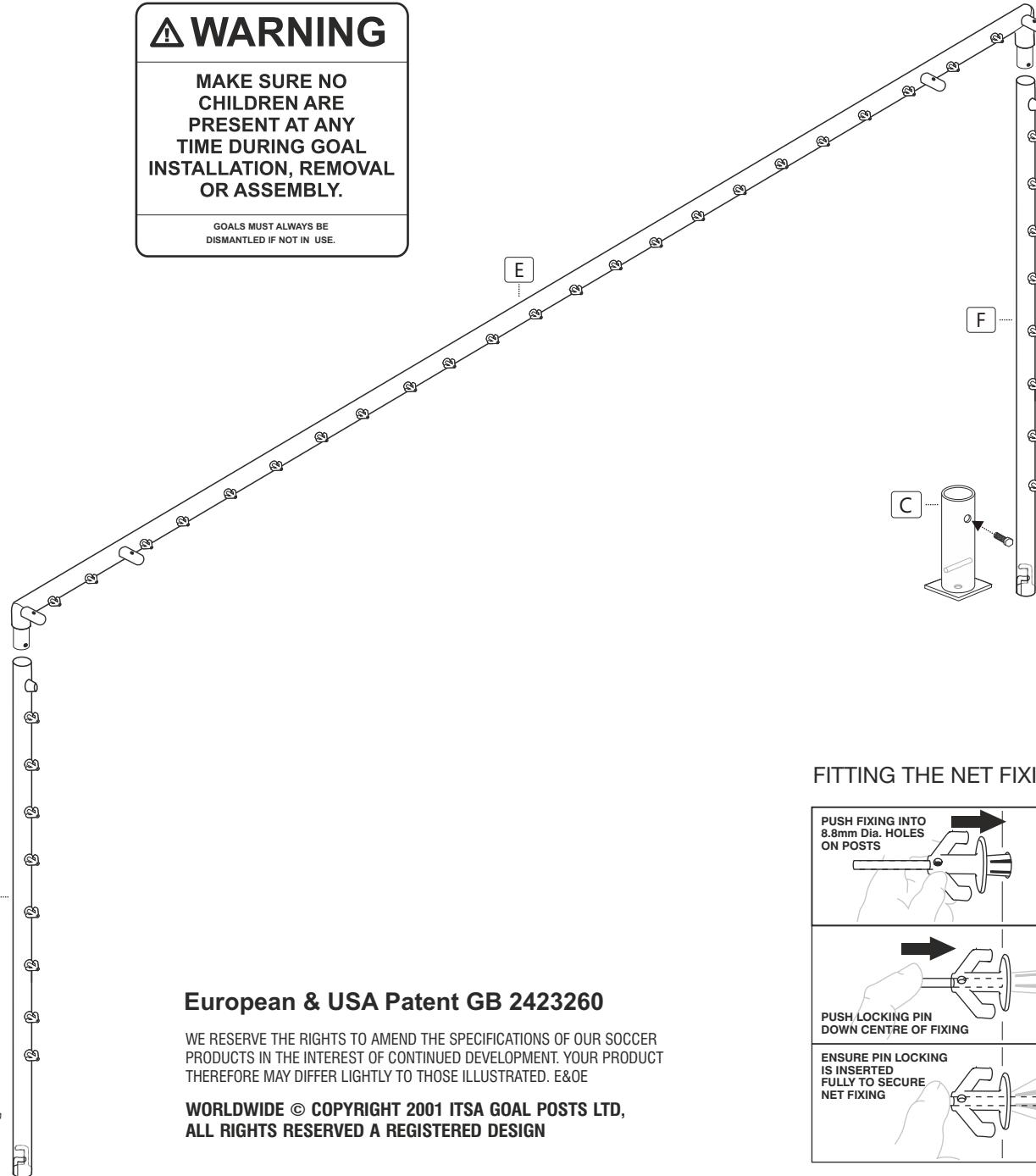

**FITTING**  
INSTRUCTION

**tsaGoal**  
[www.itsagoal.net](http://www.itsagoal.net)

SPARE PARTS TEL: 0114 24 34 200

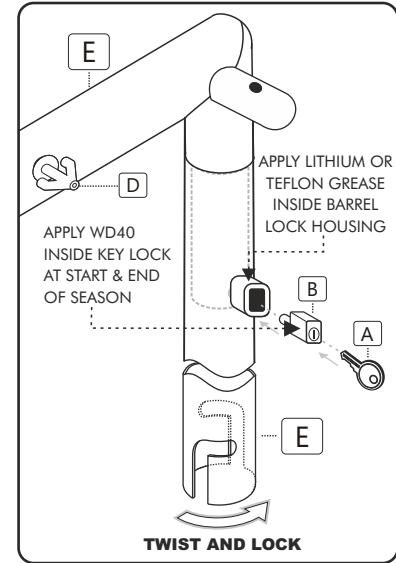

## ANTI VANDAL SECURE SYSTEM

Our innovative Anti-Vandal system.

**O**ur Steel goal posts cannot be stolen, lifted out or have the crossbar removed by vandals. A safe fast and reliable system that offers total security and accountability.

## FITTING THE NET FIXINGS

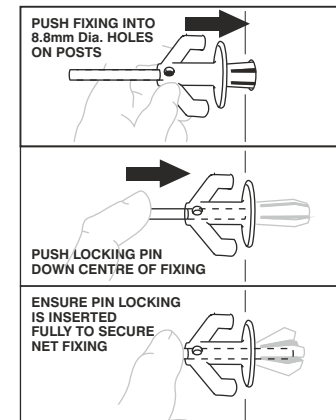

INSERT NET FIXINGS INTO HOLES ON REAR OF GOAL. A LOCKING PIN IS LOCATED ON THE TOP OF THE NET FIXING.

## DO NOT THROW THE LOCKING PINS

PUSH LOCKING PIN FULLY INTO THE NET FIXING, THIS WILL SECURE IT IN PLACE. REMOVING THE NET FIXING THE LOCKING PIN CAN BE PUSHED COMPLETELY THROUGH THE FIXING BY USING A ROD LESS THAN 4MM IN DIAMETER (SUCH AS A BLUNT NAIL). WHEN PUSHED FULLY THROUGH THE PIN WILL DROP INSIDE THE POST AND ALLOW THE FIXING TO BE PULLED OUT. SAVE THE LOCKING PIN IF FIXINGS ARE TO BE REUSED.

## European & USA Patent GB 2423260

WE RESERVE THE RIGHTS TO AMEND THE SPECIFICATIONS OF OUR SOCCER PRODUCTS IN THE INTEREST OF CONTINUED DEVELOPMENT. YOUR PRODUCT THEREFORE MAY DIFFER LIGHTLY TO THOSE ILLUSTRATED. E&OE

WORLDWIDE © COPYRIGHT 2001 ITSA GOAL POSTS LTD,  
ALL RIGHTS RESERVED A REGISTERED DESIGN

# Installation of ground Sockets

1. Mark out Pitch & Check pitch is square before installing sockets. For assistance in doing this please visit ([www.itsagoal.net](http://www.itsagoal.net))
2. When you are sure the pitch is square mark the position of the centre of the goal line (see overleaf)  
NOTE: half the width of the goal either side of the goal line centre point = Upright positions  
I.e. A 24' x 8' goal will have uprights positioned 12' either side of the centre point

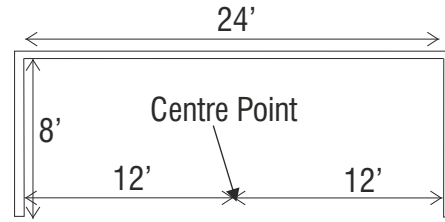

THE MEASUREMENT MUST RUN TO THE INSIDE OF THE UPRIGHTS & TO THE UNDERSIDE OF THE CROSSBAR.

3. Put one upright in at one end of the marked out pitch first. Ensure that they are at the correct height and that they are vertical not leaning to the side, backwards or forwards. (Use a level and timber supports to hold in place until concrete has hardened. It is advisable to add lithium or teflon grease to the bottom of the uprights posts before inserting.
4. Once the socket has hardened and secured, you can use this with the upright inserted to support the rest of the goal whilst the second socket is concreted in place.

Position the second upright in to it's socket and fit the crossbar, bolt or lock in place. Ensure the goal is lined up correctly on your goal line. I.e. Place both uprights in with the crossbar secured in place. The first upright and crossbar attached will help to support the newly concreted second upright with crossbar attached while setting.

## NEVER INSTALL GOALS WITH CHILDREN PRESENT

5. Level up the second upright as before & check crossbar is running parallel to the ground. Support second upright with timber (to prevent leaning) until concrete has hardened.

If you have not created a drainage hole in concrete - push rod through before concrete hardens off. It is a good idea to use a level on the crossbar also and then take any imperfections out in the ground level after the goal has completely settled. Never install or dismantle goalpost with children in the near vicinity. If children are likely to be drawn to your installation. Stay with goal until concrete has fully set. Do not take any risks.

These goals must only be used with the correct ground sockets provided by I.T.S.A. Goal. They must be concreted in position correctly as shown and as per the relevant safety standards. BS EN748 - BS 8462 & BS 8461 (Goal Maintenance).

You can contact our technical director on mobile 07974745768 for any help on installation.

## FITTING BOX NETS

ATTACH THE NET TO THE GOAL FRAME, TO THE CROSSBAR FIRST THEN BOTH UPRIGHTS. WE ADVISE TWO CORDS BE FIXED TO THE NET AT EACH POLE POSITION. ONE CORD IS MEASURED TO THE POLE POSITION WITH A PLASTIC CLIP AND THE OTHER IS LONGER AND LOOSE TO TAKE DOWN THE NET SUPPORT POLE AND TENSION AND TIE OFF THE NET. TO INSTALL THE NET, CLIP TO EACH NET SUPPORT POLE THEN LIFT POLE INTO THE GROUND SOCKET AND THIS WILL LIFT NET INTO PLACE AND FORM THE BOX NET. USE THE SECOND CORD TO TENSION THE NET. FINALLY PEG OUT THE BASE OF THE NET OR USE GROUND FRAMES TO WEIGHT NET TO THE GROUND

MAKE SURE YOU HAVE THE LONGEST LENGTH (8') - A, FITTING ONTO THE UPRIGHT & THE SHORTEST LENGTH (5') - B, TO THE GROUND.

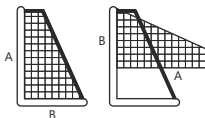

## GROUND SOCKET Installation diagram

- 1 Upright
- 2 Sport Surface
- 3 Concrete Block
- 4 Ground Socket
- 5 Drainage Hole
- 6 Socket Bolt
7. Pea Gravel

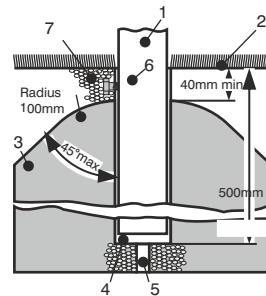

Note 'Socket bolt' must be inserted to prevent ingress of soil into ground socket. Put a dab of grease on it and insert the screw into the hole and just leave it in place. At any time in the future it can be locked'.

## WARNINGS

MAKE SURE NO CHILDREN ARE PRESENT AT ANY TIME DURING GOAL INSTALLATION, REMOVAL OR ASSEMBLY

CHECK THE POSITION OF ANY UNDERGROUND SERVICES BEFORE EXCAVATION. WE TAKE NO RESPONSIBILITY FOR ANY DAMAGE OR INJURY CAUSED IN THIS MANNER.

WARNING: DO NOT TOUCH OVERHEAD SERVICES WITH POLES OR ANY PARTS. CHECK THE POSITION OF ANY OVERHEAD SERVICES WHEN SETTING UP OR DISMANTLING. POWER LINES, TELEPHONE CABELS ETC.

DO NOT SWING ON ANY NET SUPPORT POLE OR GOAL POST SECTION.

IT IS RECOMMENDED THAT AFTER USE GROUND SOCKET HOLE ARE COVERED WITH OUR CAPS THAT ARE SOLD SEPARATELY.

TO AVOID DAMAGE WHEN DISMANTLING THE GOAL FOLLOW THESE GUIDELINES: DO NOT USE ANY COMPONENTS PARTS IF THEY ARE DAMAGED OR BROKEN. IT IS ADVISABLE IN EXTREME WINDY CONDITIONS TO DISMANTLE THE GOAL AND STORE AWAY.

### NET SUPPORT POLE SOCKET Installation to European Standards BS EN748

- 1 Upright
- 2 Sport Surface
- 3 Concrete Block
- 4 Ground Socket
- 5 Drainage Hole

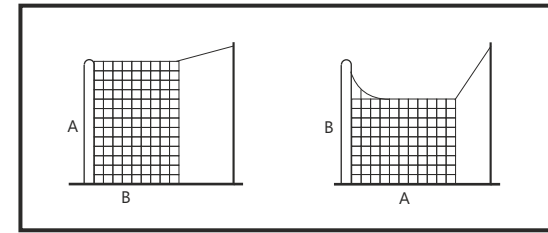
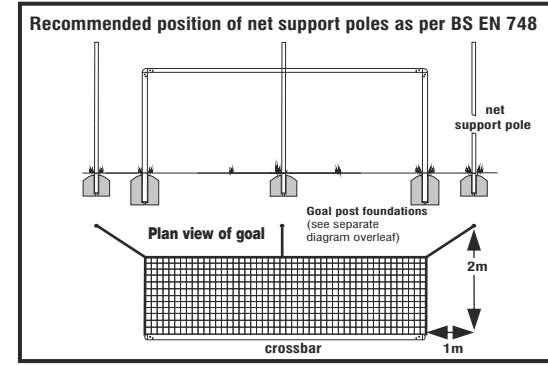
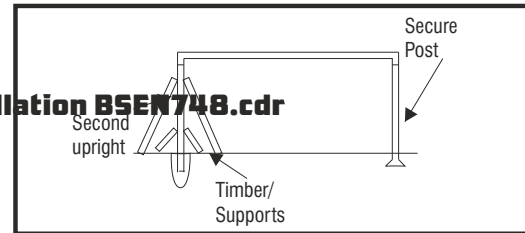

### TYPES OF NETS & SUPPORTS AVAILABLE FOR SOCKETED GOALS

*Nets and Supports sold Separately.*

STANDARD SHAPE  
With removable 'D' supports.

USE GROUND PEGS TO PEG NET

BOX STYLE SHAPE  
(with two support poles and extra cords)

NET SUPPORT POLE

BOX STYLE SHAPE  
(with three support poles and extra cords)

NET SUPPORT POLE

STANDARD SHAPED NETS CAN ALSO BE USED WITH NET SUPPORT POLES.

### GOALPOST PROTECTOR TAPE

AVAILABLE SEPARATELY

Protects paintwork at the base of the upright.

TO PURCHASE VISIT [www.soccertackle.com](http://www.soccertackle.com)

### TWIST AND LOCK SOCKET CAPS

ARE AVAILABLE SEPARATELY

To cover and protect Ground Socket.

TO PURCHASE VISIT [www.soccertackle.com](http://www.soccertackle.com)



FOR FURTHER INFORMATION & ADDITIONAL FITTING INSTRUCTIONS VISIT OUR WEB SITE:  
[www.itsagoal.net](http://www.itsagoal.net)  
MEADOWHALL SOCCER CENTRE  
FERRARS ROAD, TINSLEY, SHEFFIELD S9 1RZ  
TEL: 0114 243 4200