









COMPONENTS

- A** GROUND SOCKET x2 
- B** M10 SOCKET DOME SCREW AND HEX DOME NUT - 80mm LONG x4 
- C** ARROW HEAD NET FIXING with attached LOCKING PIN x40 
- AK** HEX KEY x1 
- GN** STANDARD GOAL NET - 21'x 7' x1 

POST SECTIONS

Aluminium Sections

- D** LEFT CROSSBAR SECTION x1 
- E** RIGHT CROSSBAR SECTION x1 
- F** UPRIGHT SECTION x2 

ALUMINIUM SOCKETED

21' X 7' FIXED POSITION SOCKETED GOAL

(21' x 7') - Two section crossbar.

FITTING INSTRUCTION

tsaGoal
www.itsagoal.net

SPARE PARTS TEL: 0114 24 34 200

WARNING

MAKE SURE NO CHILDREN ARE PRESENT AT ANY TIME DURING GOAL INSTALLATION, REMOVAL OR ASSEMBLY.

GOALS MUST ALWAYS BE DISMANTLED IF NOT IN USE.

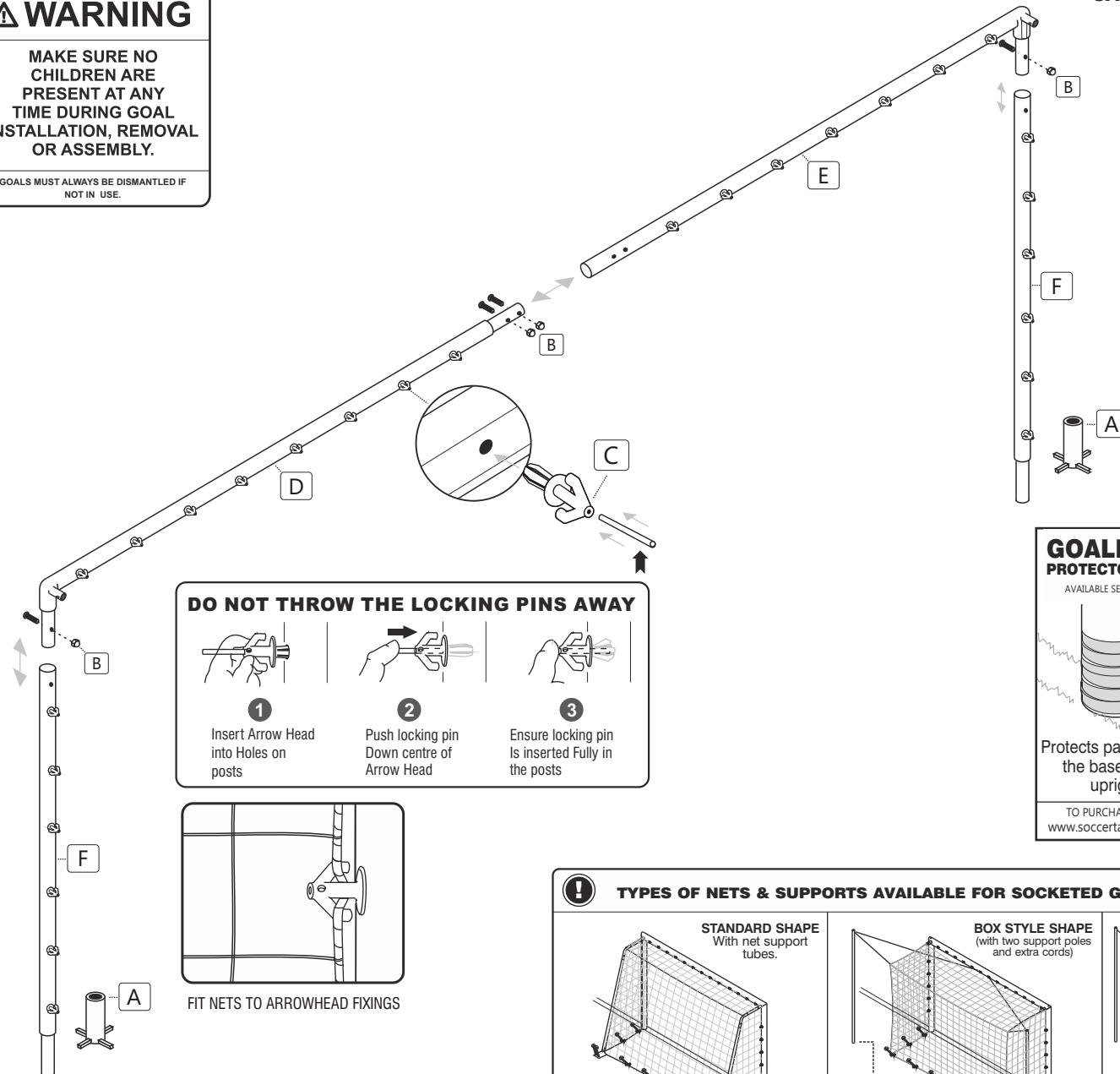

DO NOT THROW THE LOCKING PINS AWAY

- 1** Insert Arrow Head into Holes on posts
- 2** Push locking pin Down centre of Arrow Head
- 3** Ensure locking pin is inserted Fully in the posts

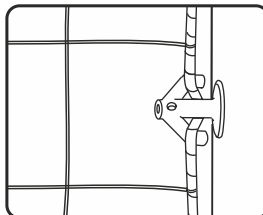

FIT NETS TO ARROWHEAD FIXINGS

REAR SLOPPING NET SUPPORTS

AVAILABLE SEPARATELY

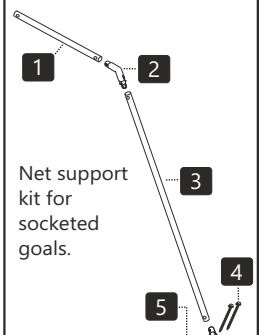

TO BE PURCHASED FROM OUR WEBSITE SOCCERTACKLE.COM

GOALPOST PROTECTOR TAPE

AVAILABLE SEPARATELY

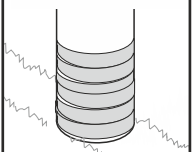

Protects paintwork at the base of the upright.

TO PURCHASE VISIT www.soccertackle.com

PLASTIC GROUND SOCKET CAPS

ARE AVAILABLE SEPARATELY

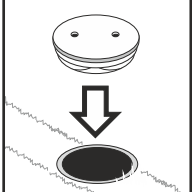

To cover and protect Ground Socket.

TO PURCHASE VISIT www.soccertackle.com

GROUND SOCKET Installation diagram

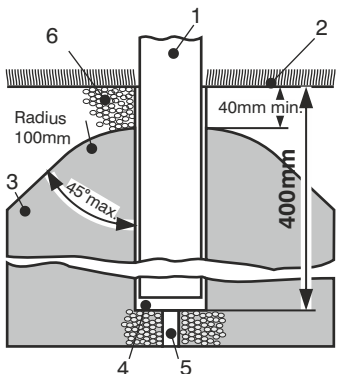

- 1 Upright
- 2 Sport Surface
- 3 Concrete Block
- 4 Ground Socket
- 5 Drainage Hole
- 6. Pea Gravel

! TYPES OF NETS & SUPPORTS AVAILABLE FOR SOCKETED GOALS

Nets and Supports sold Separately.

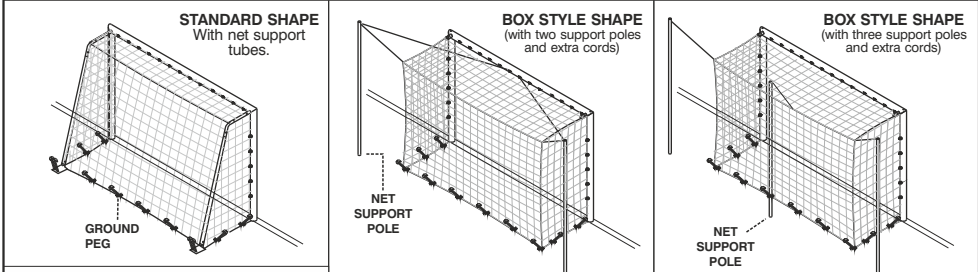

GROUND PEG **x33** 

STANDARD SHAPED NETS CAN ALSO BE USED WITH NET SUPPORT POLES.

WORLDWIDE © COPYRIGHT 2001 ITSA GOAL POSTS LTD. ALL RIGHTS RESERVED A REGISTERED DESIGN. WE RESERVE THE RIGHTS TO AMEND THE SPECIFICATIONS OF OUR SOCCER PRODUCTS IN THE INTEREST OF CONTINUED DEVELOPMENT. YOUR PRODUCT THEREFORE MAY DIFFER SLIGHTLY TO THOSE ILLUSTRATED. E&OE

FITTING THE NET FIXINGS

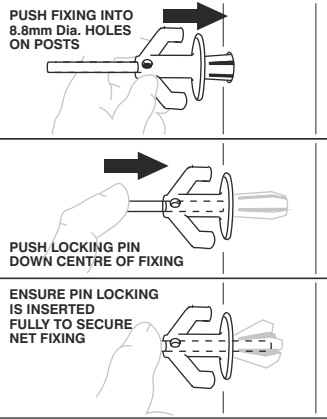

INSERT NET FIXINGS INTO HOLES ON REAR OF GOAL. A LOCKING PIN IS LOCATED ON THE TOP OF THE NET FIXING. DO NOT THROW THE LOCKING PINS AWAY

PUSH LOCKING PIN FULLY INTO THE NET FIXING, THIS WILL SECURE IT IN PLACE. REMOVING THE NET FIXING
THE LOCKING PIN CAN BE PUSHED COMPLETELY THROUGH THE FIXING BY USING A ROD LESS THAN 4MM IN DIAMETER (SUCH AS A BLUNT NAIL). WHEN PUSHED FULLY THROUGH THE PIN WILL DROP INSIDE THE POST AND ALLOW THE FIXING TO BE PULLED OUT. **SAVE THE LOCKING PIN IF FIXINGS ARE TO BE REUSED.**

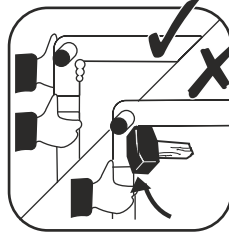

NEVER STRIKE THE POSTS WITH A HAMMER OR SOLID OBJECT. ALWAYS PRISE APART OR LIGHTLY TAP THE CORNER SECTIONS WITH A RUBBER Mallet. MAKE SURE POSTS AND CORNERS ARE IN LINE DURING ASSEMBLY AND DISASSEMBLY.



DO NOT SWING ON CROSSBARS
CROSSBARS WILL NOT BE REPLACED WITHIN THE GUARANTEE PERIOD IF BROKEN BY SWINGING OR CLIMBING OR ANY OTHER MISUSE.

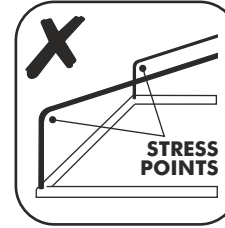

NEVER ALLOW THE GOAL TO FALL FORWARDS WHILE THE STANCHIONS ARE FITTED, THIS MAY CAUSE THEM TO BREAK.

WHEN LIFTING OR LOWERING GOAL ENSURE AREA IS CLEAR OF BYSTANDERS TO PREVENT INJURY.

CARE & MAINTENANCE

WE ADVISE ADULT SUPERVISION DURING ASSEMBLY AND USE.

OBSERVE AND FOLLOW WARNING LABELS ATTACHED TO GOAL. DO NOT USE GOALS WITH ANY DAMAGED OR MISSING COMPONENTS. SPARE PARTS AND REPLACEMENT NETS ARE READILY AVAILABLE

TELEPHONE OUR GOAL-LINE 0114 243 4200

DAMAGED COMPONENTS REQUESTED UNDER GUARANTEE MUST BE RETURNED FOR INSPECTION. FAILURE TO FOLLOW THE WARNINGS, FITTING INSTRUCTIONS CONTAINED IN THIS DOCUMENT, MAY INVALIDATE YOUR GUARANTEE.

IF NET HOOKS DO NOT STAY IN POSITION WHEN PIN IS INSERTED, THE PIN MAY HAVE BECOME WORN, AS A TEMPORARY MEASURE YOU CAN WRAP TAPE AROUND THE MIDDLE OF THE PIN AND THIS SHOULD HELP TIGHTEN THE PIN INSIDE THE HOOK.
HARD GROUND CONDITIONS: TO PREVENT DAMAGE TO GOAL OR ITS COMPONENTS, LOOSEN SOIL WITH A STEEL POLE AND MOISTEN WITH SOME WATER BEFORE INSERTING THE GROUND ANCHOR.

NOTE: WHEN USING A BAG PLEASE PACK THE GOAL SECTIONS CAREFULLY INTO THE BAG. THE COMPONENTS ARE DESIGNED TO FIT INTO THE BAG EFFICIENTLY AND THEREFORE. DO NOT UNDER ANY CIRCUMSTANCE THROW THE COMPONENTS INTO THE BAG AND THEN FORCE THE ZIP TO CLOSE AS THIS WILL BREAK THE ZIP FASTENER.

BAG MAINTENANCE - SPONGE BAG DOWN WITH HOT SOAPY WATER. ZIP WILL RUN EASIER IF YOU RUB BOTH SIDES OF THE ZIP TRACK WITH CANDLE WAX

GROUND ANCHORS - NOTE: ALWAYS ENSURE ALIGNMENT OF GROUND SPIKES IS CORRECT TO ALLOW UPRIGHTS TO EASILY SLIDE OVER TOP OF SPIKE. DO NOT USE FRONT GROUND SPIKES IF THEY BECOME MISSHAPEN OR DAMAGED AS THIS COULD CAUSE DAMAGE TO THE BASE OF UPRIGHT.

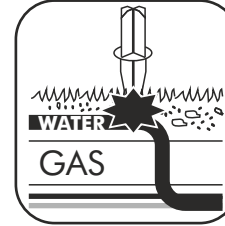

WARNING: CHECK THE POSITION OF ANY UNDERGROUND SERVICES BEFORE USING THE GROUND SPIKES AND PEGS. WE TAKE NO RESPONSIBILITY FOR ANY DAMAGE OR INJURY CAUSED IN THIS MANNER. OUR GROUND ANCHOR SYSTEM IS DESIGNED TO GIVE SLIGHTLY UNDER HEAVY IMPACT TO HELP PREVENT SERIOUS INJURY. TO LOOSEN TAP SIDES OF SPIKE WITH HAMMER BEFORE EXTRACTING. YOU MAY NEED TO INSTALL GROUND SOCKETS FILLED WITH SAND IF USED IN THE SAME POSITION REGULARLY.

CLEANING

AT THE END OF THE SEASON NETS CAN BE TIED INTO A BUNDLE PUT INTO AN OLD PILLOW CASE, AND TIE SHUT (NOT TO DAMAGE WASHING MACHINE) AND WASHED IN A COOL WASH WITH NORMAL WASHING POWDER. THE GOAL FRAME CAN BE WASHED WITH HOT SOAPY WATER. ANY SCUFF MARKS CAN BE RUBBED OFF WITH A LIGHT ABRASIVE SCOURING PAD.

WARNING

THE GOAL IS DESIGNED FOR ASSOCIATION FOOTBALL (SOCCER) ONLY AND NO OTHER PURPOSE.
CHECK ALL FITTINGS ARE FULLY SECURED BEFORE USE AND CHECKED PERIODICALLY. ENSURE THAT THE UPRIGHTS AND BACK STANCHIONS ARE STRAIGHT AND PROPERLY ALIGNED BEFORE FITTING THE NET.
WHEN LIFTING OR LOWERING GOAL ENSURE AREA IS CLEAR OF BYSTANDERS TO PREVENT INJURY.
IT IS ADVISABLE IN EXTREME WINDY CONDITIONS TO DISMANTLE THE GOAL AND STORE AWAY. WHEN DISMANTLING THE GOAL ENSURE THAT ALL FITTINGS ARE PACKED AWAY AND THAT NOTHING IS LEFT ON THE PLAYING SURFACE.
DO NOT USE DAMAGED NETS.
NEVER USE GOALS WITHOUT SECURING BOLTS.
GOALS MUST NEVER BE LEFT UP OR USED UNLESS THEY ARE PROPERLY FITTED WITH GROUND SPIKES AND ANCHORS WITH NET ATTACHED AND SECURELY PEGGED DOWN.
DO NOT AT ANY TIME USE YOUR GOAL WITHOUT GROUND ANCHORS.
DO NOT CLIMB ON THE NET OR GOAL FRAME.
DO NOT DROP ANY HEAVY OBJECTS ON ENDS OF TUBES.

FITTING THE NET

ATTACH THE NET TO THE GOAL FRAME
SQUARE MESH NET IS CUT TO SHAPE SIMPLY THROW OVER THE FRAME AND FIT EACH END ONTO TOP STANCHION BY SECURING ON CORNER NET FIXINGS, THEN ATTACH TO FIXINGS ALONG CROSSBAR, THEN TO UPRIGHTS.

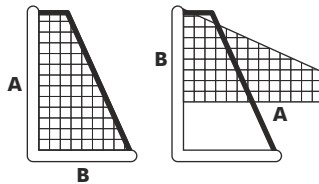

NOTE: IF YOUR NET DOES NOT FIT THE FIRST TIME, YOU ARE FITTING IT TO THE GOAL FRAME UPSIDE DOWN I.E. THAT IS TO SAY THE NET FROM THE CROSSBAR TO THE FLOOR (A) IS LONGER THAN THE LENGTH OF THE NET TO THE BOTTOM OF THE UPRIGHT.(B)

NOTE: IF YOU SETTING YOUR GOAL(S) UP REGULARLY THEN IT IS A GOOD IDEA TO ATTACH SOME TAPE TO THE NET SO YOU CAN EASILY IDENTIFY THE TOP CORNERS. WE RECOMMEND THAT ONLY NETS WITH 100MM X 100MM MESH BE USED WITH CHILDREN TO COVER HEAD ENTRAPMENT REGULATIONS 120MM X 120MM MESH IS ACCEPTABLE FOR USE BY ADULTS.

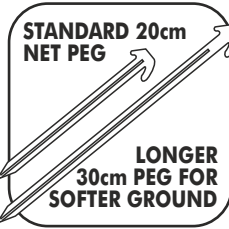

WARNING: WE RECOMMEND A RISK ASSESSMENT OF SOIL CONDITIONS. EG. FOR SOFT, VERY WET OR SANDY GROUND WE STRONGLY RECOMMEND OUR LONGER 300MM NET PEG IS USED (AVAILABLE SEPARATELY). FREESTANDING GOALS WITH COUNTER BALANCE WEIGHTS MAY BE MORE SUITABLE FOR EXTREME GROUND CONDITIONS.

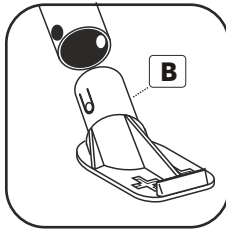

REAR GROUND ANCHORS
Once fitted Rear Ground Anchor can stay connected to Back Stanchion Tube for storage.

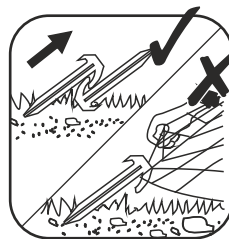

TO AVOID DAMAGE TO NETS -- DO NOT REMOVE PEGS BY PULLING FROM GROUND WITH BOTTOM OF NET. REMOVE THE PEGS AS SHOWN USING ANOTHER PEG.

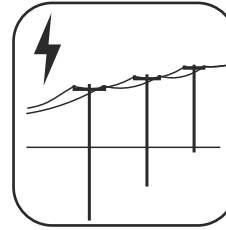

WARNING: DO NOT TOUCH OVERHEAD SERVICES WITH GOALPOST SECTIONS. CHECK THE POSITION OF ANY OVERHEAD SERVICES WHEN SETTING UP OR DISMANTLING THE GOALS, EG. POWER LINES, TELEPHONE CABLES ETC.

STORAGE

A HANDY 280cm GOAL CARRY BAG TO TRANSPORT AND STORE YOUR PORTABLE GOAL IS AVAILABLE SEPARATELY.

NO LIABILITY IS ACCEPTED WHATSOEVER BY THE COMPANY ITS EMPLOYEES OR AGENTS FOR DAMAGED LOSS OR INJURY CAUSED BY NEGLIGENCE OR MISUSE.

IT IS ADVISABLE IN ANY CONTACT SPORT TO TAKE OUT THE RELEVANT INSURANCE'S TO COVER AGAINST INJURY BOTH FROM TAKING PART, EQUIPMENT AND OTHER UNFORESEEABLE CIRCUMSTANCES.

TYPES OF NETS & SUPPORTS AVAILABLE FOR SOCKETED GOALS
Nets and Supports sold Separately.

BOX STYLE SHAPE
(with two support poles and extra cords)

NET SUPPORT POLE

BOX STYLE SHAPE
(with three support poles and extra cords)

NET SUPPORT POLE

GROUND PEG **x38**

STANDARD SHAPED NETS CAN ALSO BE USED WITH NET SUPPORT POLES.