

16' X 7' MULTI-SURFACE YOUTH GOAL (16' x 7') - Two section crossbar.

FITTING INSTRUCTION

tsaGoal

www.itsagoal.net

TEL: 0114 24 34 200
SPARE PARTS

COMPONENTS

A	CORNER BRACKET 4 HOLES	x4	
X	CORNER BRACKET UPRIGHT 8 HOLES	x2	
B	SPIGOT	x4	
C	BLANKING CAP	x2	
D	MULTI-SURFACE ANCHOR	x4	
E	GROUND PEG	x8	
F	STANCHION ELBOW	x2	
G	LOWER BACK STANCHION CONNECTOR	x2	
H	LARGE QUICK RELEASE BUTTON	x12	
I	SMALL QUICK RELEASE BUTTON	x8	
J	NET TIE	x12	
K	STRAIGHT CONNECTOR	x1	
L	ARROW HEAD NET FIXING with attached LOCKING PIN	x31	
NET	GOAL NET 16' x 7'	x1	
NH	GROUND FRAME NET FIXING HOOK	x28	

POST SECTIONS

M	CROSSBAR SECTION	x2	
N	BACKBAR SECTION	x2	
O	SIDEBAR SECTION	x2	
P	UPRIGHT SECTION	x2	
Q	TOP STANCHION TUBE	x2	
R	BACK STANCHION TUBE	x2	

CARE & MAINTENANCE - see separate sheet supplied or visit www.itsagoal.net for additional copies. Our goalpost if used correctly will last many years. We do also offer a full spare part service and if your goals need refurbishment this can be arranged

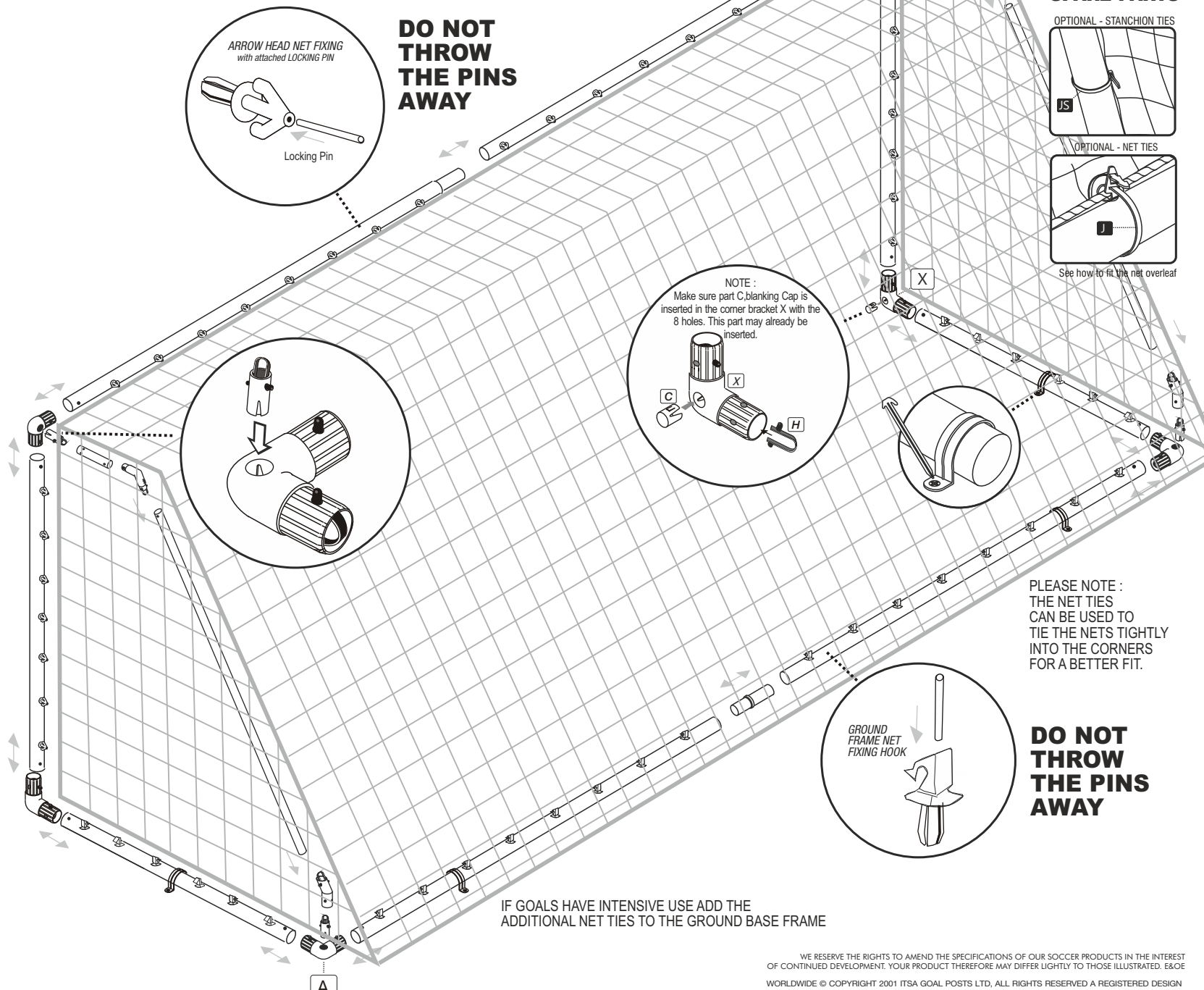

DO NOT THROW THE PINS AWAY

ARROW HEAD NET FIXING with attached LOCKING PIN

Locking Pin

NOTE : Make sure part C, blanking Cap is inserted in the corner bracket X with the 8 holes. This part may already be inserted.

OPTIONAL - STANCHION TIES

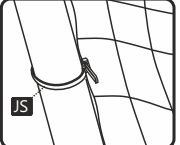

OPTIONAL - NET TIES

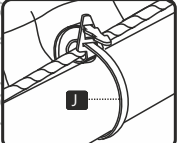

See how to fit the net overleaf

PLEASE NOTE : THE NET TIES CAN BE USED TO TIE THE NETS TIGHTLY INTO THE CORNERS FOR A BETTER FIT.

GROUND FRAME NET FIXING HOOK

DO NOT THROW THE PINS AWAY

IF GOALS HAVE INTENSIVE USE ADD THE ADDITIONAL NET TIES TO THE GROUND BASE FRAME

STEP 1

Lay out all Posts & components

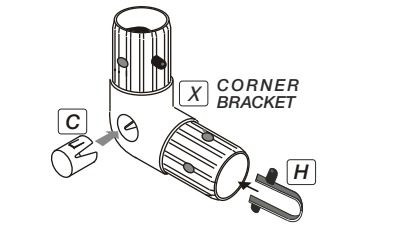
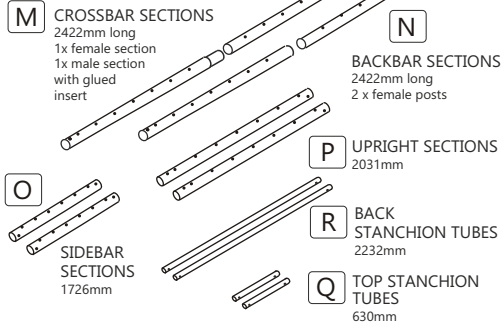

STEP 2

Insert Blanking Cap part C and insert Large Quick Release Button H (x2) into Corner Bracket X. (NOTE: Corner Bracket X is different from Corner Bracket A. Corner Bracket X is to be fitted into the upright posts and has 8 holes.

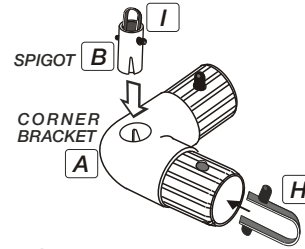

STEP 3

Insert Small Quick Release Black Button I into the Spigot B. Insert Spigot B and insert H (x2) into Corner Bracket A. (NOTE: Corner Bracket A has 4 holes)

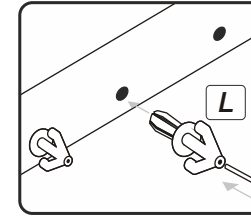

STEP 4

Insert Arrow Head Net Fixings L into Upright Posts and Crossbar. **DO NOT THROW AWAY LOCKING PINS**

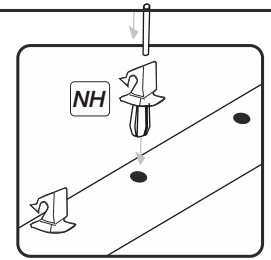

STEP 5

Insert Ground Frame net Fixings NH into Back bar and Side bar. See details about removing burrs overleaf. **DO NOT THROW AWAY LOCKING PINS**

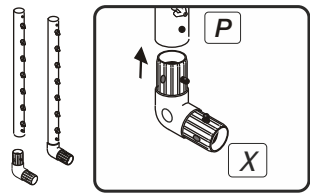

STEP 7

Connect M, Male to M Female crossbar section

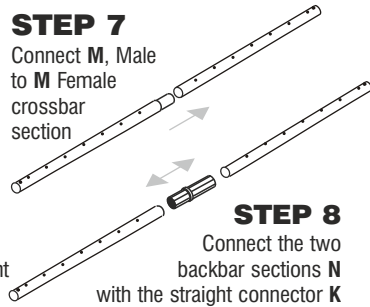

STEP 8

Connect the two backbar sections N with the straight connector K

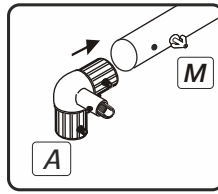

STEP 9 Insert Corner Brackets A into each end of the 16' crossbar M

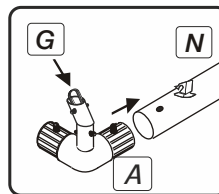

STEP 10 Insert Corner Brackets A into each end of the 16' Backbar N

STEP 11

Attach Side bars O to the ground back bar by slotting into the corners brackets

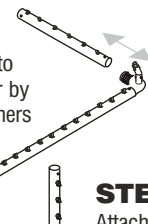

STEP 12

Attach Uprights P to the Side bars O

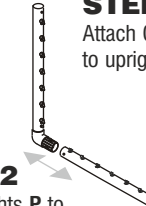

STEP 13

Attach Crossbar M to uprights P

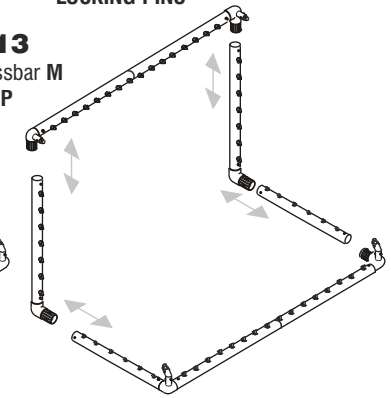

STEP 6

Insert Corner Brackets X into the upright posts P (uprights have logos on the side)

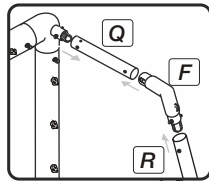

STEP 14

Join top tubes Q to elbows F and back tubes R and connect to the goalpost.

STEP 15

Attach two of the Ground Anchors D&E see details of use overleaf.

STEP 16

Fit the net - attach the net to each corner first where the crossbar meets the uprights. On the back ground bar at the back of the goal extra netting can be rolled and tied to the back ground bar for a neat finish. Finally add the two remaining anchors on the ground back bar with the netting underneath as shown.

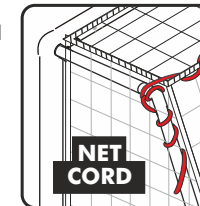
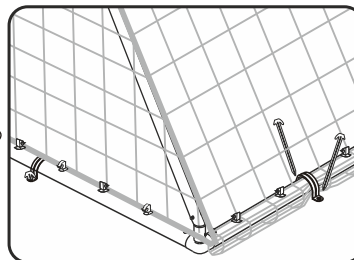

To define the roof of the net Tie the cord to one side and pull the net cord tight and wrap neatly down and around the stanchion tube if you are regularly attaching or detaching the net then apply coloured tape to the roof corners to help identify.

FASTER MATCH DAY
ASSEMBLY & DISASSEMBLY

The goal net can be left attached to the pre-assembled goal post side frames. After games detach crossbar and back bar for storage. We advise fitting the optional net ties to the side frames and stanchions.

OPTIONAL - Net ties are ideal to fit nets tightly to the side ground frames and stanchions. This is ideally when nets are left attached to the fully assembled side

GROUND PEG REMOVAL

USE THE HOOK ON THE END OF THE RED GROUND PEG TO REMOVE PEGS FROM THE GROUND OR USE A CLAW HAMMER FOR PEGS THAT ARE DIFFICULT TO REMOVE.

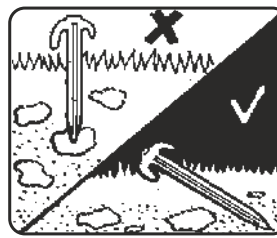
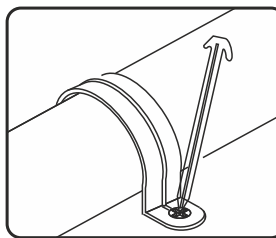
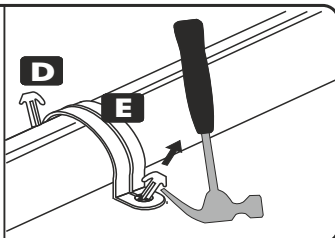

LONGER GROUND PEGS ARE AVAILABLE SEPARATELY:
STANDARD 200mm
SOFTER GROUND 300mm

Longer pegs are to be used on sandy or soft ground earth. A risk assessment of soil conditions suitability should be carried out when anchors are to be used.

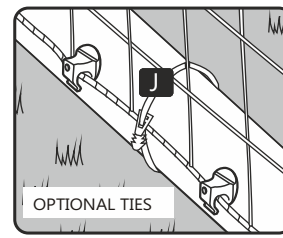
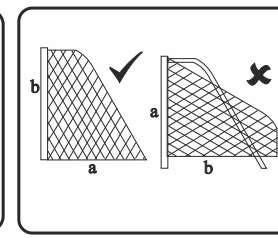

NET FITTING

DO NOT THROW THE PINS AWAY

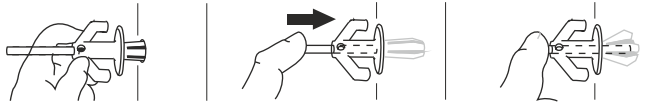

1
Insert Arrow Head into Holes on posts

2
Push locking pin Down centre of Arrow Head

3
Ensure locking pin is inserted Fully in the posts

GROUND FRAME NET FIXING

DO NOT THROW THE LOCKING PINS AWAY

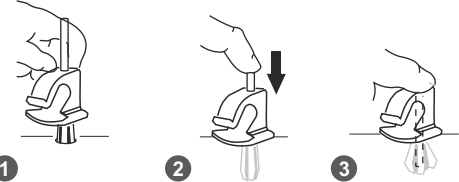

1
Insert ground frame net fixings into holes on ground frame

2
Push locking pin down centre

3
Ensure locking pin is inserted fully

On back frame fix all the same way with opening facing inwards. On side frames along the ground fit alternate

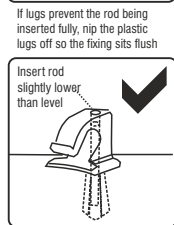
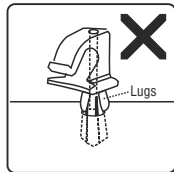

Push the rod slightly inside. Make sure the rod does not go fully through and fall out or the fixing will not lock.

CHECK THE NET

Open net and check the lengths of a and b correspond with the diagram below.

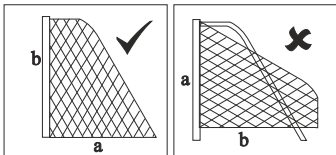

SQUARE MESH Net is cut to shape. Simply throw over the frame and fit each end onto top stanchion by securing on each corner of crossbar. NOTE: If your net does not fit the first time, you may be fitting it to the goal frame upside down i.e. that is to say the net from the crossbar to the floor (a) is longer than the length of the net to the bottom of the upright. (b)

NET TIES

Ensure the teeth of the Net tie are facing you (see step 1). Loop the Net Tie around the Net Cord and slide the end into the horizontal slot and pull tight onto Net Cord (see step 1-2).

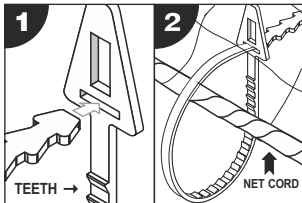

The vertical slot of the Net Tie is used to secure the net to the post. Loop the Net Tie around the post and insert through vertical slot and twist to lock. (steps 3 - 5).

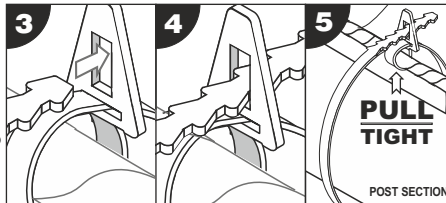

Any excess Net Tie can looped back into the vertical slot. This will also secure the net tie in a fixed position (steps 6 - 8). If Net Ties are to be removed after use then do not loop back into vertical slot.

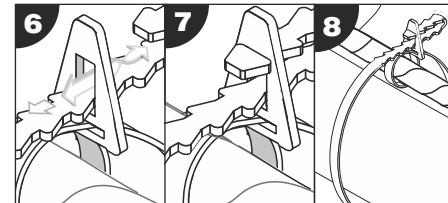

ANCHORING YOUR GOAL

WARNING: Check the position of any underground services before using the ground anchors and pegs. We take no responsibility for any damage or injury caused in this manner. **HARD SURFACES:** to prevent damage to goal or it's components, loosen soil with a steel pole and moisten with some water before inserting the ground anchors. Do not use the goal in sub zero temperatures.

ANCHORING YOUR GOAL ON GRASS - POSITION YOUR GOAL ON A LEVEL PLAYING SURFACE. PLACE THE MULTI-SURFACE ANCHOR OVER EACH SIDE OF THE GROUND FRAME (POSITIONS SHOWN) HAMMER THE PEGS THROUGH THE HOLES (DO NOT USE METAL HAMMERS USE RUBBER MALLETS) ON THE ANCHOR DOWN UNDER THE FRAME INTO THE GRASS ADDITIONAL ANCHORS OR LARGER PEGS CAN BE PURCHASED FOR USE ON SOFT GROUND OR SAND. THESE ANCHORS CAN BE USED FOR HARD SURFACES SUCH AS TARMAC WITH OPTIONAL BOLTS. ON HOT/SUNNY DAYS TARMACADAM SOFTENS AND THEREFORE TO ANCHOR YOUR GOAL PROPERLY YOU MUST-

1 DIG HOLES IN YOUR TARMAC FILL HOLES WITH CONCRETE , 2 DRILL TWO 14MM HOLES 12CM APART AND 70MM DEPTH. 3 POSITION GOAL AND ANCHOR, INSERT AND TIGHTEN BOLT. FOR OTHER SURFACES SUCH AS WOODEN SPORTS HALL FLOORS WOOD SCREWS (INSTEAD OF BOLTS) OR COUNTER BALANCE WEIGHTS CAN ALSO BE USED (SUPPLIED SEPARATELY).

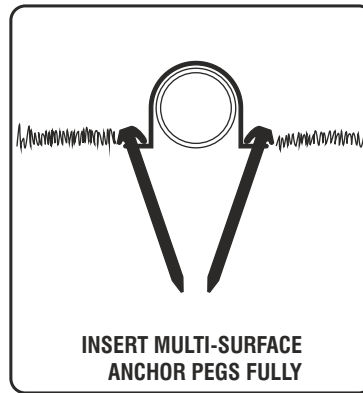

THIS METHOD SECURELY ANCHORS YOUR GOAL DOWN ON TARMAC

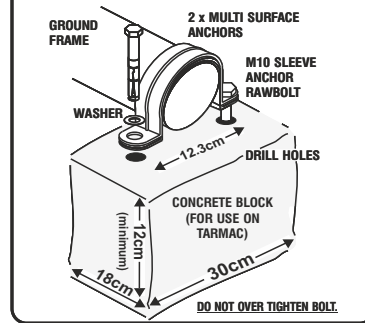

We advise adult supervision during assembly and use. Observe and follow warning labels attached to goal. Do not use any components, nets or parts if they are damaged or broken. Spare parts and replacement nets are readily available. If others are to install your goal you should show them how to erect and dismantle the goal and hand them a copy of the fitting instruction. If you lose your instructions copies can be attained from our company website. To avoid damage when dismantling the goal follow these guidelines: it is advisable in extreme windy conditions to dismantle the goal and store away. Do not drop any heavy objects on ends of tubes. When dismantling the goal ensure that all fittings are packed away and that non are left on the playing surface. Warning goals must never be left up or used unless they are properly fitted with ground anchors with net attached and securely pegged down.

Hard surfaces: to prevent damage to goal or it's components, loosen soil with a steel pole and moisten with some water before inserting the ground anchors. Do not use the goal in sub zero temperatures. warning labels should be replaced when worn and we recommend replacing them every two years -spare labels available. damaged components requested under guarantee must be returned for inspection. Failure to follow the warnings, fitting instructions contained in this document, may invalidate your guarantee. The company, its agents and representatives do not accept any product liability if used outside the EU. Use of the product in other countries outside the EU including the USA is not covered and appropriate insurance should be taken out by the user to cover for any eventuality. We reserve the rights to amend the specifications of our soccer products in the interest of continued development. Your product therefore may differ slightly to those illustrated. Not suitable for children under 36 months until assembled due to small parts.

NOTE : All plastic extrusions vary and therefore some tubes may be looser or tighter to connector fittings. If you want to increase the diameter of the fitting just wrap masking tape around the part that fits into the tube, twist as you insert the fitting and it will grab to the tube tight ...you can make tighter fits by adding more tape.

Guarantee

REGISTER YOUR GUARANTEE

To register for your guarantee visit www.itsagoal.net scroll to the bottom of the page and click on the link 'Guarantee' and follow the instructions. Thank you.



SPARE PARTS
TEL: 0114 24 34 200