





# COMPONENTS

- A** CHROME BARREL LOCK & KEY **x2** 
- B** GROUND SOCKET **x2** 
- B1** SOCKET BOLT 45mm THREAD LENGTH **x2** 
- C** TWIST AND LOCK NET FIXING **x40** 

# POST SECTIONS

- F** CROSSBAR SECTION (Elliptical) **x1**
- H** UPRIGHT SECTION (Elliptical) **x2**

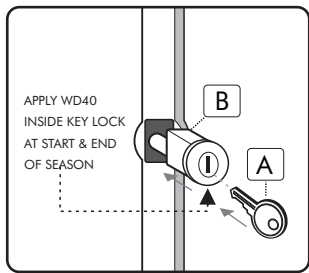

**LOCK & SECURE PATENTED SYSTEM**

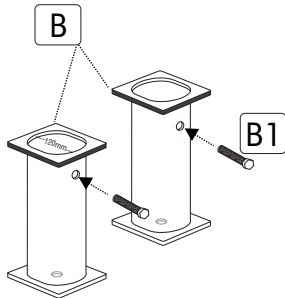

# WARNING

**MAKE SURE NO CHILDREN ARE PRESENT AT ANY TIME DURING GOAL INSTALLATION, REMOVAL OR ASSEMBLY.**

GOALS MUST ALWAYS BE DISMANTLED IF NOT IN USE.

**STADIUM SOCKETED**

# 24' X 8' STADIUM ELLIPTICAL SOCKETED GOAL

**FITTING INSTRUCTION**

**tsgoal**  
www.itsgoal.net

TEL: 0114 24 34 200

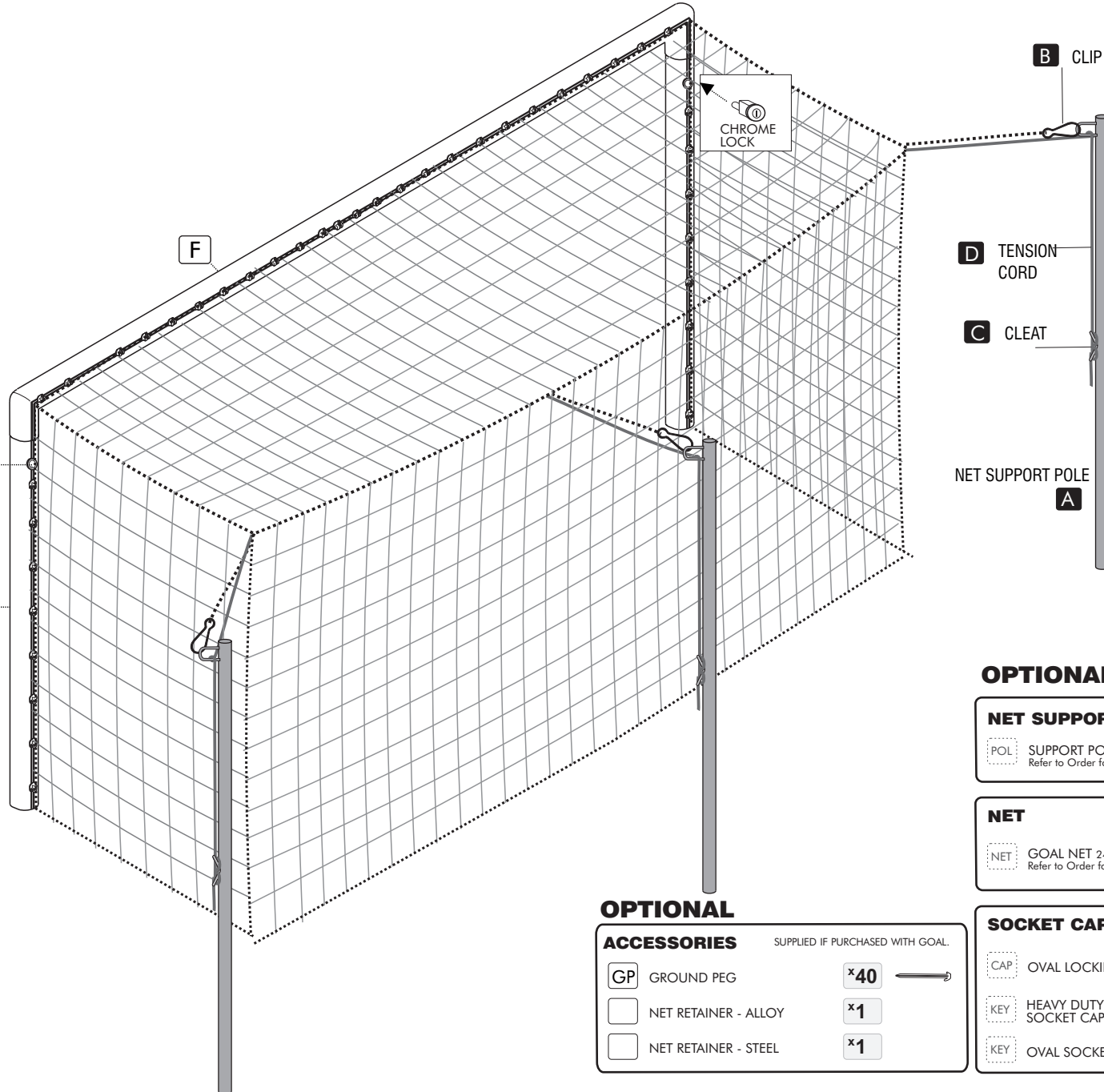

- B** CLIP
- D** TENSION CORD
- C** CLEAT
- A** NET SUPPORT POLE

# OPTIONAL



## NET SUPPORT

- POL** SUPPORT POLE  
Refer to Order for correct TYPE

## NET

- NET** GOAL NET 24' X 8'  
Refer to Order for correct TYPE **x1**

## SOCKET CAP

- CAP** OVAL LOCKING SOCKET CAP **x2** 
- KEY** HEAVY DUTY OVAL LOCKING SOCKET CAP **x2** 
- KEY** OVAL SOCKET CAP KEY **x1** 

# OPTIONAL

## ACCESSORIES

SUPPLIED IF PURCHASED WITH GOAL.

- GP** GROUND PEG **x40** 
- NET RETAINER - ALLOY **x1**
- NET RETAINER - STEEL **x1**

# GROUND SOCKET *Installation diagram*

- 1 Upright
- 2 Sport Surface
- 3 Concrete Block
- 4 Ground Socket
- 5 Drainage Hole
- 6. Socket Bolt
- 7. Pea Gravel

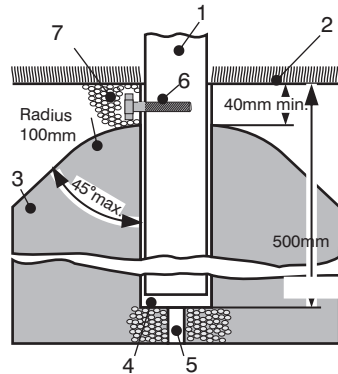

Note 'Socket bolt' must be inserted to prevent ingress of soil into ground socket. Put a dab of grease on it and insert the screw into the hole and just leave it in place. At any time in the future it can be locked'.

## IMPORTANT- GROUND SOCKET

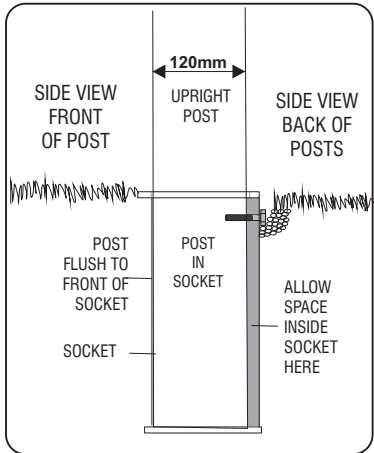

Grey area on diagram denotes the space that should be present once goal is inserted in socket. When fitting any ground socket, tape the top over to prevent concrete dropping inside the socket DURING INSTALLATION OF THE GROUND SOCKET. Locate Upright locking screw to the back of the post when fitting.

## GOAL POST in ground socket side view

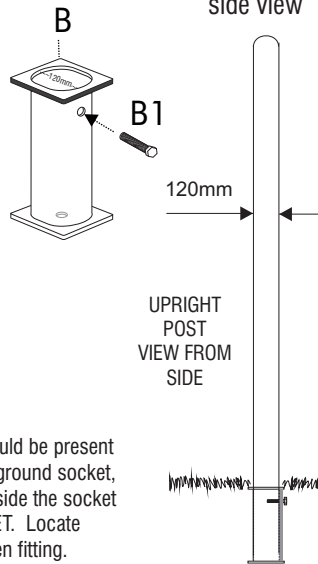

**GOALPOST PROTECTOR TAPE**  
AVAILABLE SEPARATELY

Protects paintwork at the base of the upright.

TO PURCHASE VISIT [www.soccertackle.com](http://www.soccertackle.com)

**LOCKABLE GROUND SOCKET CAPS**  
ARE AVAILABLE SEPARATELY

To cover and protect Ground Socket.

TO PURCHASE VISIT [www.soccertackle.com](http://www.soccertackle.com)



For spare parts or additional products call the goal-line 0114 2434200 or visit our online supplier [www.soccertackle.com](http://www.soccertackle.com)

## TWIST & LOCK FIXINGS

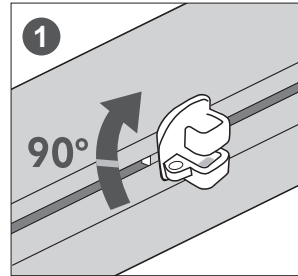

Fit into groove on goalpost section.

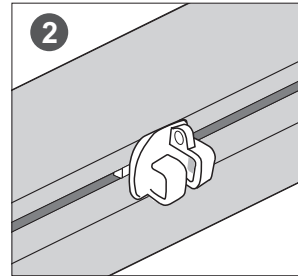

Twist 90 degrees to secure. Position the fixings no more than 340mm apart.

## NET FITTING

### STEP 1

Attach the net to the twist and lock net fixings on the crossbar and uprights. Fit the corners of the net to the top of each upright first then clip the net onto all other net fixings.

### STEP 2

With the steel net support pole laid flat on the floor attach the clip(B) to the end/top of the net support pole. Lift the support pole in the air and insert into the ground socket so that one pole is in place at one end.

### STEP 3

With the first steel net support pole(A) in place, repeat this step and fit the middle support pole and then the final end support pole.

### STEP 4

All net support poles will be in place now with the net hanging loosely. Now use the tension cord marked to pull the box nets tightly to create a tensioned straight box shape. Pull the cord back and down and wrap in a figure of eight onto the cleat to hold in place. Repeat this step on each pole.

Finally peg your goal net to the ground if the goal is being used on grass or alternatively fit the net to the optional hinged net retainer - see separate fitting instructions.

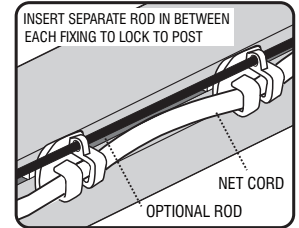
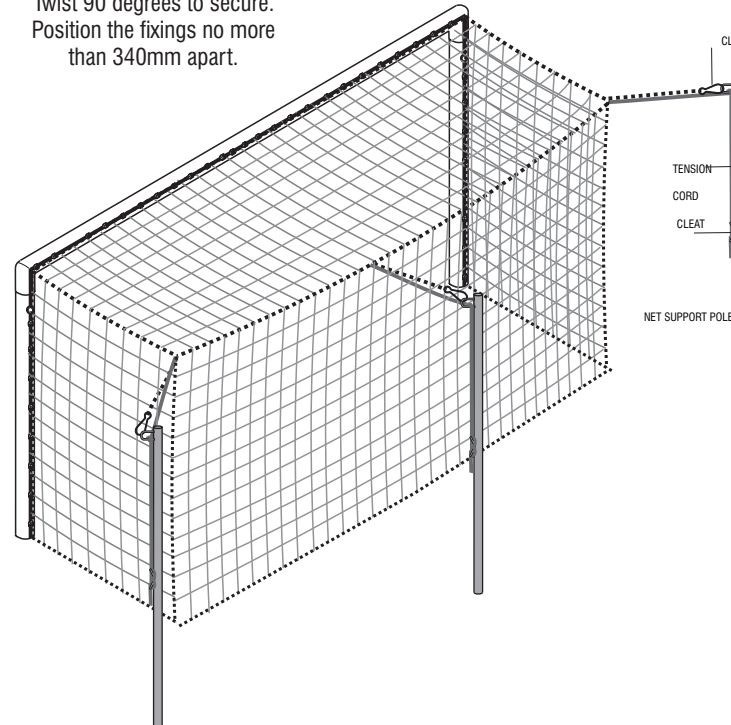

THREAD NET CORD INTO NET FIXINGS

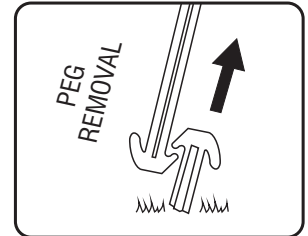
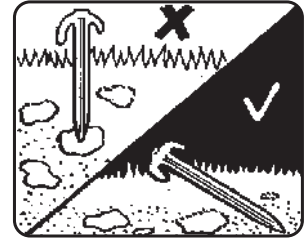

## OPTIONAL NET RETAINER

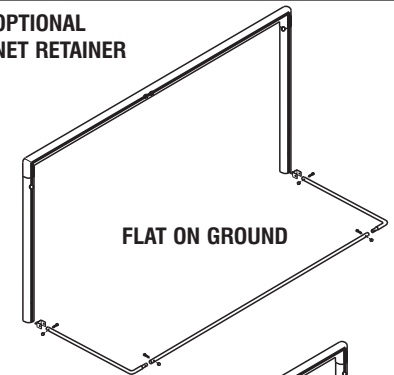

FOLD UPRIGHT WHEN CUTTING GRASS. WITH CENTRAL SUPPORT