

COMPONENTS

A	MULTI-SURFACE ANCHOR	x4	
B	GROUND PEG	x8	
C	BRASS BARREL LOCK	x2	
D	KEY	x2	
E	STANCHION NET TIES - SMALL	x8	
F	TWIST AND LOCK NET FIXING	x48	
NET	GOAL NET	x1	

POST SECTIONS

Aluminium Sections

G	LEFT SIDE FRAME	x1	
H	RIGHT SIDE FRAME	x1	
I	CROSSBAR SECTION 120mm x 100mm Diameter (Elliptical)	x1	

GROUND BACK BAR

J	BACK BAR SECTION	x1	
C	BRASS BARREL LOCK	x2	
D	KEY	x2	
A	MULTI-SURFACE ANCHOR	x2	
B	GROUND PEG	x4	
F	TWIST AND LOCK NET FIXING	x16	

TWIST & LOCK NET FIXINGS

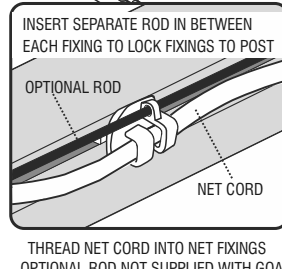
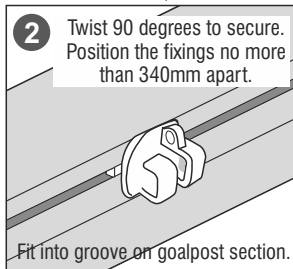
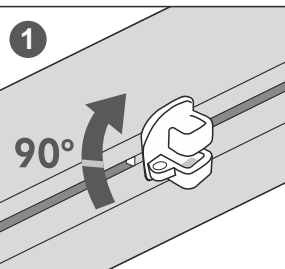

THREAD NET CORD INTO NET FIXINGS
OPTIONAL ROD NOT SUPPLIED WITH GOAL

8' X 6' ELLIPTICAL FOLDAWAY

⚠ WARNING

ALL GOALS MUST BE SECURELY ANCHORED AND OR CORRECTLY COUNTER BALANCED (SUPPLIED SEPARATELY) IN ACCORDANCE WITH CURRENT GOALPOST SAFETY STANDARDS AT ALL TIMES. CONTACT THE FOOTBALL ASSOCIATION FOR THE LATEST SAFETY INFORMATION & READ OUR CARE AND MAINTENANCE DETAILS.

THE GOAL MUST BE HANDLED CAREFULLY - DO NOT DRAG GOALS. DO NOT USE GOAL FRAMES WITHOUT LOCKS. GOALS MUST ALWAYS BE FULLY DISMANTLED AFTER USE. THE STANCHIONS ARE FOR SUPPORTING NET ONLY; DO NOT LIFT GOAL WITH THE STANCHIONS. LONGER PEGS ARE AVAILABLE FOR USE ON SANDY GROUND. ON GRASS, A RISK ASSESSMENT OF SOIL CONDITIONS SUITABILITY SHOULD BE CARRIED OUT WHEN ANCHORS ARE TO BE USED. ANY DAMAGE CAUSED BY MIS-USE IS NOT COVERED UNDER THE GUARANTEE.

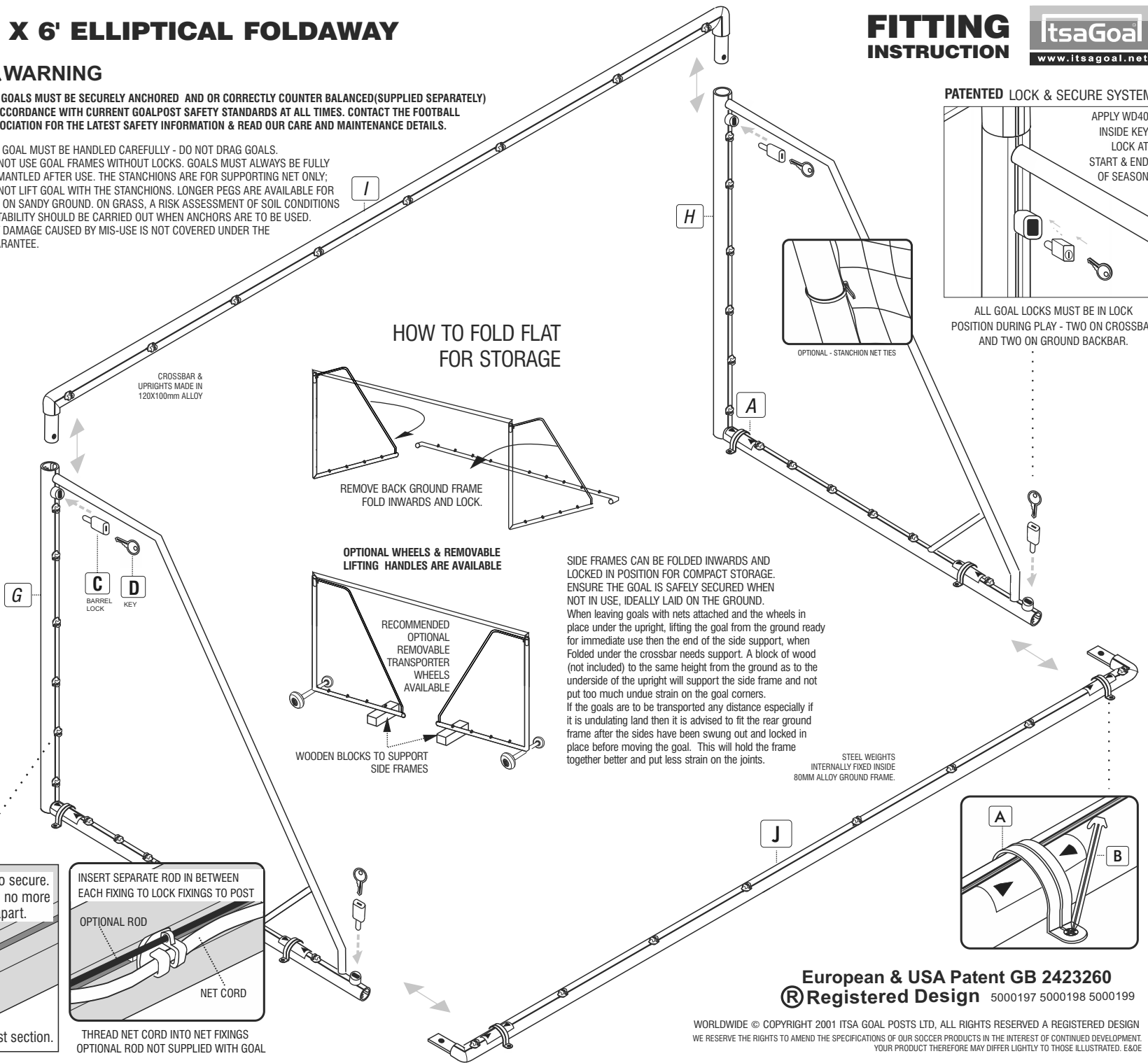

**FITTING
INSTRUCTION**

tsaGoal
www.tsagoal.net

European & USA Patent GB 2423260
® Registered Design 5000197 5000198 5000199

WORLDWIDE © COPYRIGHT 2001 ITSA GOAL POSTS LTD, ALL RIGHTS RESERVED A REGISTERED DESIGN
WE RESERVE THE RIGHTS TO AMEND THE SPECIFICATIONS OF OUR SOCCER PRODUCTS IN THE INTEREST OF CONTINUED DEVELOPMENT.
YOUR PRODUCT THEREFORE MAY DIFFER LIGHTLY TO THOSE ILLUSTRATED. E&OE

Lockable aluminium folding patented goal posts that are easy to move around use and store. Crossbar corners are welded both internally and externally to ensure they will stand up to the most rigorous conditions. The corners will not expand apart as with other goals as expansion is carried through the corner to lift the crossbar slightly and then when contracting gravity will take over. Oil and clean the lock to ensure the key is working well at all times. If a key breaks inside the lock a local locksmith will be able to remove it with a special pick. Spare keys are locks are always available. At the end of the season when the goals are not in use check all welds to ensure they have not become damaged. Check periodically through the season that the goals have not been damaged especially if they are left up in areas prone to vandalism. When installing your goals take your time and do a good job to ensure the best results and performance. The installation guides need to be read carefully prior to fixing. I can be contacted at any time on 07974745768 if you need any advice or help. To protect the life of your paintwork we suggest that 50mm wide plastic stretch tape be wrapped around the base of the posts about 600mm up from the ground to protect the paintwork from goal keepers kicking the foot of the posts to clean boots. This tape can be purchased from our web site or any local DIY store and should be renewed as and when required. It is much better however if you can ask all visiting and home goal keepers not to kick the posts. A thorough inspection each year and when goals are installed should be carried out and recorded. A goal post maintenance sheet is available to be downloaded from our web site www.itsagoal.net. Problems should be recorded, noted down and acted upon straight away. **DO NOT WALK OR STAND UNDER THE CROSSBAR WHEN MOVING OR STORING THE GOALS - DO NOT USE THE GOALS IF THEY ARE DAMAGED IN ANY WAY - TO DO SO WOULD WEAKEN THE STRUCTURE - THEY MUST BE REPAIRED BEFORE BEING BROUGHT BACK INTO USE. NEVER USE DAMAGED GOAL POSTS. Goals need to be treated and handled with care and they will then last longer and will perform better.** Any paint chips need to be repaired as soon as possible. Rub down with emery paper to form a smooth surface down to bear metal and apply a good quality aluminium primer undercoat and then a top coat to seal the affected area. Any areas left untreated will allow water to penetrate between the powder coat finish and the base metal and if left un checked the paint work will start to peel away. Any local DIY store will supply what you need. If you treat the goalposts with respect and maintain them properly they will perform year after year.

Multi-surface anchors

Multi-surface anchors are designed to secure the freestanding goalposts to normal grass surface pitches (to 1100Newtons forward pull test). On a grass surface use the ground pegs provided in conjunction with the multi-surface anchors. If ground is softer then more ground anchors can be used to spread the load or longer pegs can be inserted. The safety ground pegs can also be used to retain your net if rear ground frames are not used with the folding goal. Always angle the pegs as shown on the fitting instructions. To remove stubborn pegs use another peg to lift out do not pull out with the anchor itself or it may damage the securing cross holding the peg in place. This is strong system designed to twist under stress and will not easily be damaged. If you are planning to anchor your goal post on tarmac the fixing positions for the multi-surface anchors need to be secure. We advise :-

1. Dig holes in your tarmac (to sizes specified in fitting instructions).
2. Fill holes with concrete, and drill two 14mm holes 12cm apart and 70mm depth.
3. Position goal and multi-surface anchors and use a suitable 10mm concrete bolt instead of the safety grass pegs. For other surfaces such as wooden sports hall floors wood screws in our multi-surface anchor or counter balance weights can be used. The total weight to conform to the current standards for the goal post topple test can be calculated using the equation stated below.

Goalpost Nets

All our square mesh nets are made to the shape of the net. If you are putting nets up each week we recommend that you locate the top corners first and mark them using tape so that you can easily identify them each time. Folding goal posts however are designed to enable the net to be left on the goal frame in the non-play position to allow swift match day installation. Place the net over the frame and fit each end onto top stanchion by securing on each corner of the crossbar and uprights using twist and lock net fixings. We recommend only nets with 100mm x 100mm mesh be used with children, to cover head entrapment regulations. Nets with 120mm x 120mm mesh are acceptable for use by adults. Nets can be tied into a bundle and placed into a pillow case (not to damage washing machine) and washed at 40 degrees Celsius with normal washing powder to keep them in tip top condition. Be aware rabbits and rodents have been known to nibble at the base of nets. If nets are left outside we advise lifting from ground level. If you have this problem sprinkle pepper along the bottom of the net and this should help deter most wild animals.

Counter balance weight system

The ITSA GOAL posts counter balance weight system consists of two counter balance weights each weighing 11kgs fastened together, 22 kilos of counterweight spread over 500mm. The counter balance weight system is used on flat level playing surfaces or where multi-surface anchors can not be used i.e. sports halls, artificial grass pitches etc. The two connected weights together can be lifted on the frame and used externally. If anchoring your freestanding goalpost is not possible, the guidance and technical notes set out by the Football Association give clear instructions for the use of counter balance weights. If you are unsure what weight you are required to use on your freestanding goal posts, you can work out the weight needed by using the following procedure.

1 Measure the height of the crossbar., 2 Measure the length of the goal's side bars. 3 Divide the height by the length. Multiply the result by 112Kg and make a note of the answer. This is the total weight in kilograms that should stabilize the goal to safety standards.

Example: A Regulation Goal, 2.44m high with a 2.025m ground sideframe the calculation would be: 2.44 divided by 2.025 = 1.205 therefore 1.205 x 112Kg = the total weight required for this goal would be 135Kg (less the weight of the back ground bar).

OPTIONAL REMOVABLE WHEEL TRANSPORTERS

The goal side frames fold neatly under the crossbar and lock away after use with Barrel Lock.

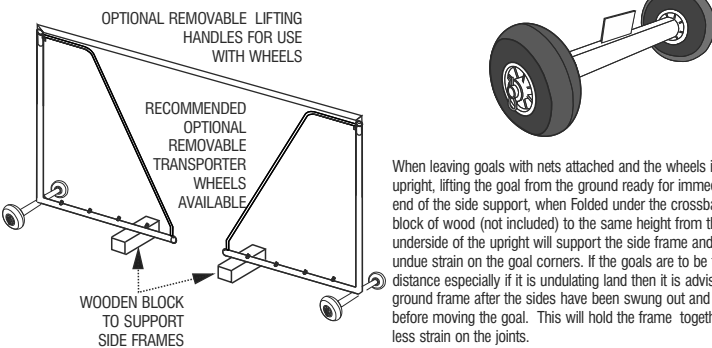

When leaving goals with nets attached and the wheels in place under the upright, lifting the goal from the ground ready for immediate use then the end of the side support, when folded under the crossbar needs support. A block of wood (not included) to the same height from the ground as to the underside of the upright will support the side frame and not put too much undue strain on the goal corners. If the goals are to be transported any distance especially if it is undulating land then it is advised to fit the rear ground frame after the sides have been swung out and locked in place before moving the goal. This will hold the frame together better and put less strain on the joints.

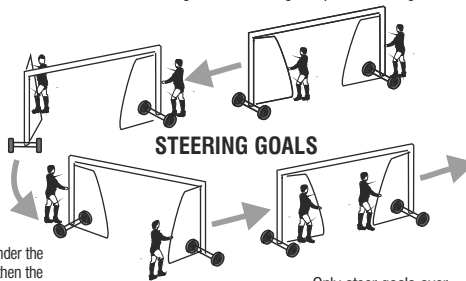
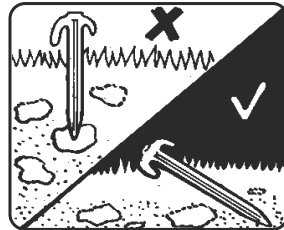
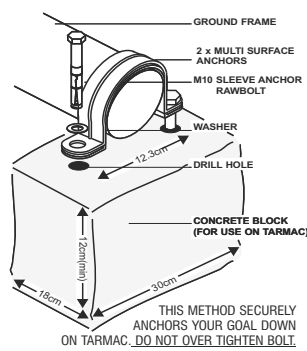
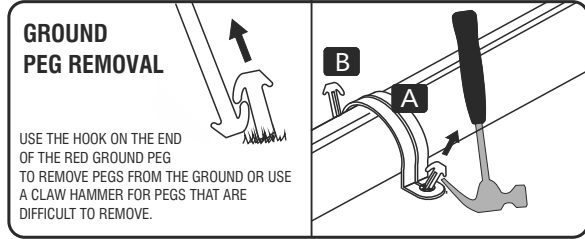

SIDE FRAMES CAN BE FOLDED INWARDS AND LOCKED IN POSITION FOR COMPACT STORAGE. ENSURE THE GOAL IS SAFELY SECURED WHEN NOT IN USE. IDEALLY LAID ON THE GROUND.

The Football Association Goals for Football Guidance Notes & Technical Details

Freestanding goals will only be safe if you stabilise them properly. Always use the accessories and anchors supplied for the purpose of anchoring a goal. The most reliable methods of stabilising freestanding goals are:

a attaching the back bar to permanent fixing points.
b using adequate weights attached to the goals backbar.
c. adequate ground anchors

We strongly recommend you use one of these methods. The diagram on the right shows a typical freestanding goal foundation that will give a permanent pitch fixing. VISIT www.itsagoal.net for up to date goal post safety information

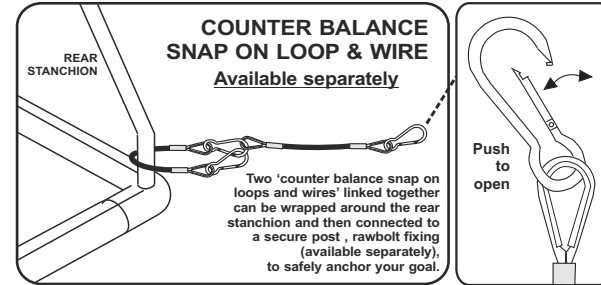
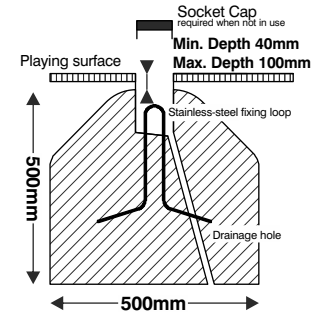

COUNTER BALANCE WEIGHT - OPTIONAL EXTRA

STEEL COUNTER BALANCE WEIGHTS For use indoors or on artificial surfaces are available separately.

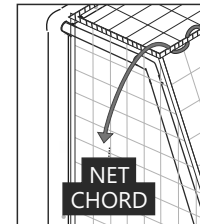

To help define the roof of the net. Tie the cord to one side and pull the net chord and wrap neatly around the stanchion section.

If you are regularly attaching or detaching the net then apply colored tape to the roof edges to help identify the roof area.

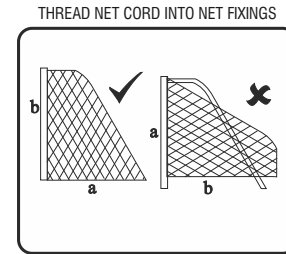
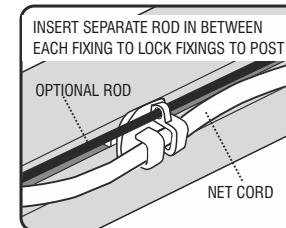

◀ **SQUARE MESH** Net is cut to shape. Simply throw over the frame and fit each end onto top stanchion by securing on each corner of crossbar. NOTE: If your net does not fit the first time, you may be fitting it to the goal frame upside down i.e. that is to say the net from the crossbar to the floor (a) is longer than the length of the net to the bottom of the upright (b).

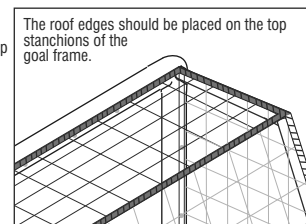

Test each goal post before use to satisfy yourself that you have enough counter balance weights attached to the goal to prevent toppling.

Chain and cable attachments Whatever method is used to stabilize a goal, any attachment chain or a wire cable between the goal and the weight, anchor, eye bolt or other fixing point should be as short as possible and not allow the back bar to lift more than 50 mm.

Care and Maintenance

1. NEVER use our goalposts without securing locks or correct fittings or in non conforming ground sockets.
2. DAMAGED COMPONENTS requested under guarantee must be returned for inspection. Failure to follow the warnings, assembly and fitting instructions contained in this document may invalidate your guarantee.

IT IS ADVISABLE IN ANY CONTACT SPORT TO TAKE OUT THE RELEVANT INSURANCES TO COVER ALL UNFORESEEABLE CIRCUMSTANCES. IT IS ADVISABLE TO CHECK YOUR GOALS WEEKLY AND UNDERTAKE ANY MAINTENANCE, CHECK PAINTWORK, CHECK NETTING, MAKES SURE ANY LOCKS OR BOLTS ARE IN PLACE , ENSURE THE FRAME IS ASSEMBLED IN ACCORDANCE WITH THE FITTING INSTRUCTIONS BEFORE EACH GAME. ANY NEW PEOPLE USING THE GOALS SHOULD BE PROVIDED WITH THIS LEAFLET AND EXTRA FITTING INSTRUCTIONS ARE AVAILABLE FROM www.itsagoal.net.

If the text is too small to read a larger easier to read copy is available upon request.

European & USA Patent GB 2423260
 Registered Design 5000197 5000198 5000199

For video demonstrations visit :
www.youtube.com/Footballgoalsposts

tsaGoal
www.itsagoal.net

SPARE PARTS
 TEL: 0114 24 34 200