

















COMPONENTS

| | | | |
|------------|--------------------------------|-----|---|
| A | CORNER BRACKET | x6 |  |
| B | SPIGOT | x4 |  |
| C | BLANKING CAP | x2 |  |
| TTE | TOP TUBE ELBOW | x2 |  |
| LB | LOWER BACK STANCHION CONNECTOR | x2 |  |
| ST | SMALL STANCHION NET TIE | x14 |  |
| LG | LARGE NET TIE | x34 |  |
| I | SMALL QUICK RELEASE BUTTON | x4 |  |
| MSA | MULTI-SURFACE ANCHOR | x3 |  |
| GP | GROUND PEG | x6 |  |
| NET | GOAL NET | x1 |  |

POST SECTIONS

| | | | |
|----------|--|----|---|
| K | CROSSBAR SECTION 2422mm LONG - 68mm Diameter | x1 |  |
| L | BACKBAR SECTION 2422mm LONG - 68mm Diameter | x1 |  |
| M | SIDEBAR SECTION 1360mm LONG - 68mm Diameter | x2 |  |
| N | UPRIGHT SECTION 1726mm LONG - 68mm Diameter | x2 |  |
| O | TOP STANCHION TUBE 400mm LONG - 40mm Diameter | x2 |  |
| P | BACK STANCHION TUBE 1896mm LONG - 40mm Diameter | x2 |  |

8' X 6' FOOTIEGOAL (with Base - one section)

SPARE PARTS AND NETS ARE AVAILABLE

TEL 01142434200 www.footiegoals.com

ANCHOR YOUR GOAL POSTS & TIE NETS TO ALL FRAMES

During a game the goal posts must have the ground anchors inserted as shown below, in order to fully hold the goal post ground sections together. The Crossbar connects into the upright posts with the corner brackets (A). It is important to fix the goal net to the larger posts with the Large Net Ties (NT). Use the Small Stanchion ties (ST) to attached the nets tightly to the net supports as indicated. See over for other helpful hints on assembly.

ST

Use the Small Stanchion ties (ST) to attach the net to the 40mm Dia net support tubes

NT

Attached the net to the 68mm Dia post sections using Large Net Ties (NT)

DO NOT USE IN EXTREME GALE FORCE WINDY CONDITIONS

CE NOT SUITABLE FOR CHILDREN UNDER 36 MONTHS UNTIL ASSEMBLED DUE TO SMALL PARTS.

TO COUNTER WEIGHT YOUR GOAL ON A HARD SURFACE SAND CAN BE USED TO WEIGHT BACKBARS. OTHER COUNTER BALANCE WEIGHTS ARE ALSO AVAILABLE.

WE RESERVE THE RIGHTS TO AMEND THE SPECIFICATIONS OF OUR SOCCER PRODUCTS IN THE INTEREST OF CONTINUED DEVELOPMENT. YOUR PRODUCT THEREFORE MAY DIFFER LIGHTLY TO THOSE ILLUSTRATED. E&OE

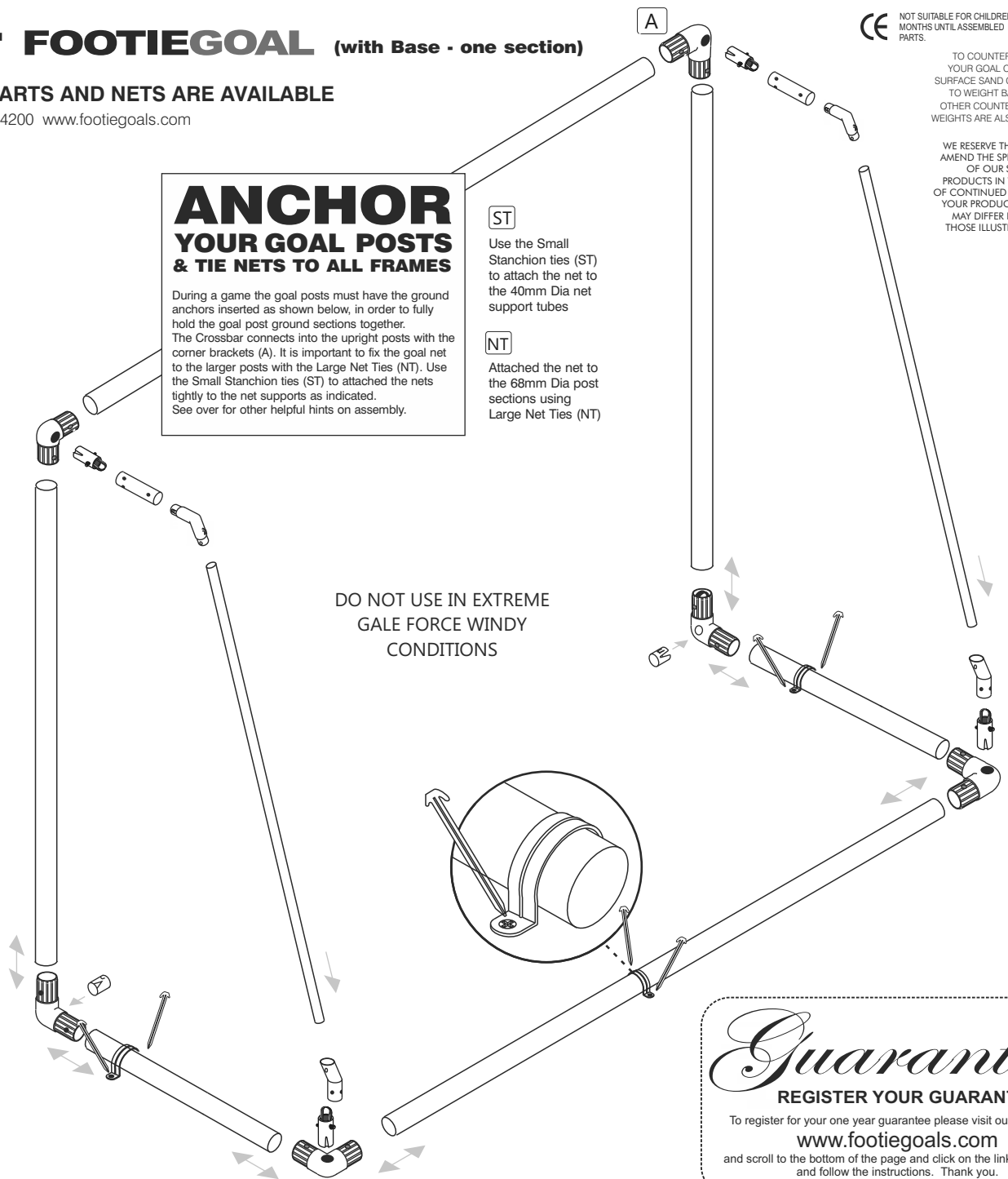

Guarantee
REGISTER YOUR GUARANTEE
 To register for your one year guarantee please visit our web page
www.footiegoals.com
 and scroll to the bottom of the page and click on the link 'Guarantee' and follow the instructions. Thank you.

STEP 1

Lay out all Posts & components

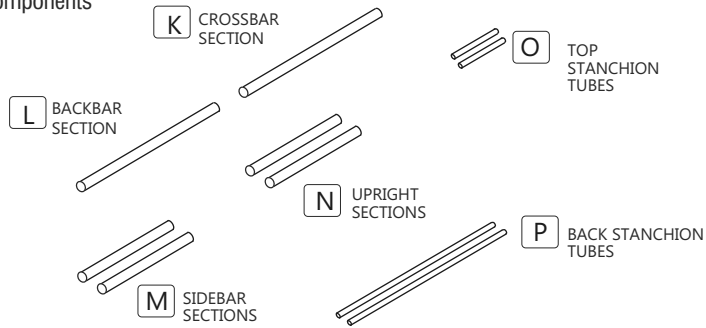

STEP 2

Insert Blanking Cap part C into two corners

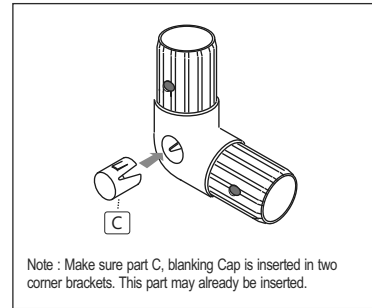

STEP 3

Insert Spigots B. into four corner brackets and insert the small quick release button I into the Spigots

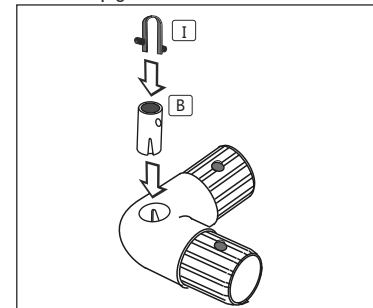

STEP 4

Insert the Lower Back Stanchion Connector LB into two of the corner bracket that already have the spigot in place.

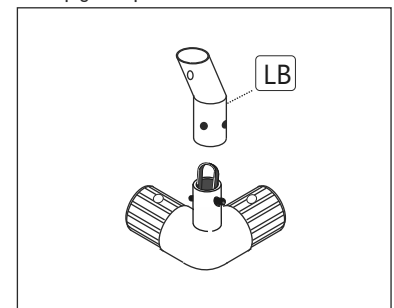

STEP 5

Firstly form the ground frame - Connect Backbar with the Corner Brackets with the Lower Back Stanchion Connectors. Slide the sidebar sections into the Corner Brackets.

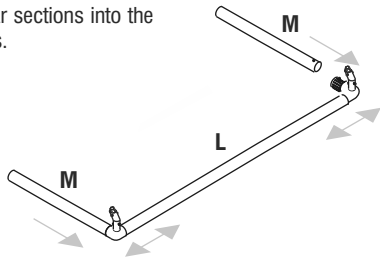

STEP 6

Insert Corner Brackets with Blanking Caps into upright posts N

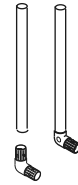

STEP 7

Insert uprights N with the Corner Brackets with Blanking Caps into the ground side bars M

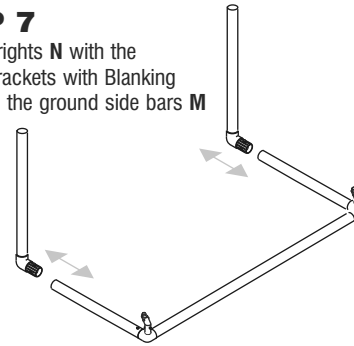

STEP 8

Insert Crossbar K add the remaining corner brackets and then slide onto the uprights

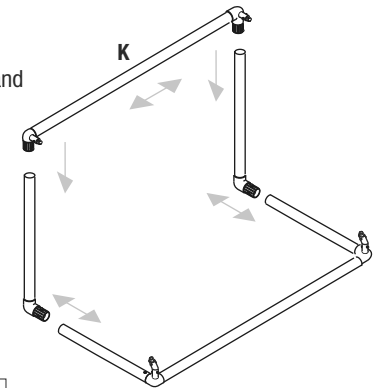

STEP 10

Attach Ground Anchors. Anchors must be inserted for the stability of the whole goal frame see details of use overleaf.

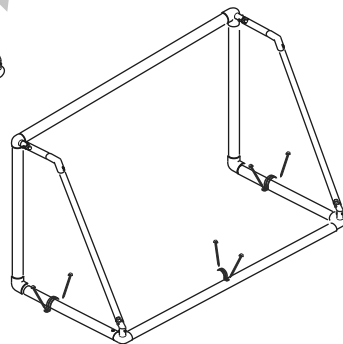

STEP 11

Start with each corner and attach the Net to the goal with the net ties. The net must be attached to use the goal.

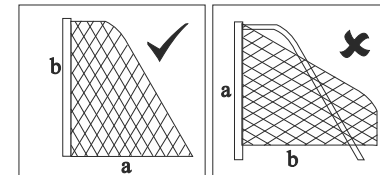

SQUARE MESH Net is cut to shape. Simply throw over the frame and fit each end onto top stanchion by securing on each corner of crossbar.

NOTE: If your net does not fit the first time, you may be fitting it to the goal frame upside down i.e. that is to say the net from the crossbar to the floor (a) is longer than the length of the net to the bottom of the upright. (b)

OPTIONAL - Net ties are ideal to fit nets tightly to the side ground frames and stanchions. This is ideally when nets are left attached to the fully assembled side frames.

TIE A CORD BETWEEN THE TOP SUPPORT TUBES TO SUPPORT THE ROOF OF THE NET (THIS CAN BE LEFT TIED MIN POSITION WHEN DISMANTLED)

IF YOU WOULD LIKE TO CREATE A TIGHT FIT BETWEEN CORNER BRACKETS AND POSTS IT IS POSSIBLE TO ADD A SMALL AMOUNT OF MASKING TAPE (NOT INCLUDING) THIS CREATES A SEAL, IDEAL IF GOALS ARE LEFT IN SITU see over.

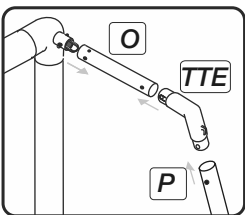

STEP 9

Join top tubes N to elbows TTE and back tubes O and connect to the goalpost.

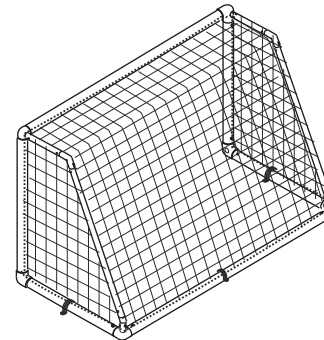

CORNER BRACKETS

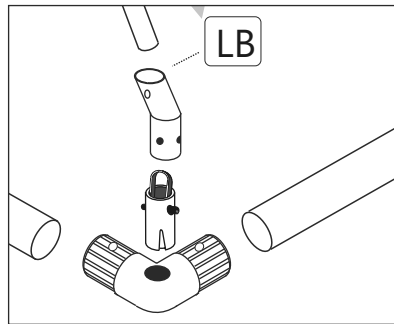
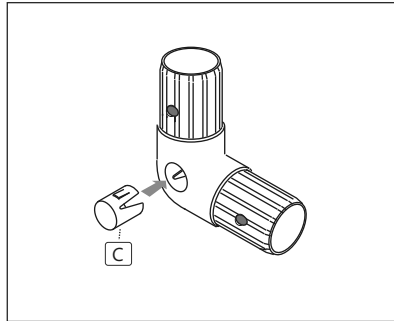
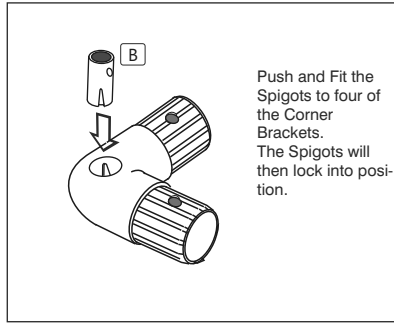

CORNER BRACKET, STANCHION & ELBOW ASSEMBLY

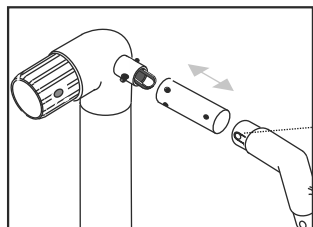

NOTE: Ensure Top Stanchion holes are aligned with the Stanchion Elbow.

press button in and out to warm up, this helps fitting, once in, this button stays connected

NET TIES : Place the small stanchion net ties on the net support stanchions. This will help extend the life of your net and keep the frame tightly fitted together. Apply the larger ties to the ground frame and the posts. We recommend placing the net ties no more than 340mm apart. The net ties supplied are designed to permanently fix the net to the goal frame. If you require to take nets on and off, other net fixings can be used.

NOTE: Goal must be anchored otherwise breakages may occur. In extreme conditions it is advised to store away. The best way to store your goal is to remove crossbar and rear back bar section leaving the net attached to the side frames. If you do this regularly then it is advisable to buy optional removable net ties. The goals are ideal when left with nets attached, for example in a garden. You must anchor your goals with the multi surface ground anchors provided. At the end of the season nets can be tied into a bundle and placed into a pillow case (not to damage washing machine) and washed at 40 C0 with normal washing powder. The ground frame can be washed with hot soapy water. Any scuff marks on posts can be rubbed off with a light abrasive scouring pad.

WARNING: Check the position of any underground services before using the ground anchors and pegs. We take no responsibility for any damage or injury caused in this manner.

NEVER use the goals without the ground anchor system. In severe weather or windy conditions it is advisable to take your goal down as damage is not covered by the guarantee in such circumstances. If you find the nets are worn along the floor it may be rodents, by spreading pepper along the base frame rodents will be deterred. It is advisable in any contact sport to take out the relevant insurance's to cover against injury both from taking part, equipment and other unforeseeable circumstances.

Crossbars will not be replaced within the guarantee period if broken by swinging or climbing or any other misuse. **DO NOT** try to glue any damaged fixings. Plastic materials in this product vary and this may cause the plastic to break. Always replace any damaged components.

NOTE : All plastic extrusions vary and therefore some tubes may be looser or tighter to connector fittings. If you want to increase the diameter of the fitting just wrap masking tape around the part that fits into the tube, twist as you insert the fitting and it will grab to the tube tight. You can make tighter fits by adding more tape.

SQUARE MESH Net is cut to shape. Simply throw over the frame and fit each end onto top stanchion by securing on each corner of crossbar.

NOTE: If your net does not fit the first time, you may be fitting it to the goal frame upside down i.e. that is to say the net from the crossbar to the floor (a) is longer than the length of the net to the bottom of the upright.(b)

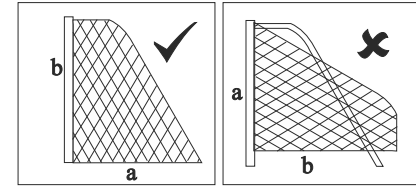

We advise adult supervision during assembly and use. Observe and follow warning labels attached to goal. Do not use any components, nets or parts if they are damaged or broken. Spare parts and replacement nets are readily available. If others are to install your goal you should show them how to erect and dismantle the goal and hand them a copy of the fitting instruction. If you lose your instructions copies can be attained from our company website. To avoid damage when dismantling the goal follow these guidelines: it is advisable in extreme windy conditions to dismantle the goal and store away. Do not drop any heavy objects on ends of tubes. When dismantling the goal ensure that all fittings are packed away and that non are left on the playing surface. Warning goals must never be left up or used unless they are properly fitted with ground anchors with net attached and securely pegged down.

Hard surfaces: to prevent damage to goal or it's components, loosen soil with a steel pole and moisten with some water before inserting the ground anchors. Do not use the goal in sub zero temperatures. warning labels should be replaced when worn and we recommend replacing them every two years -spare labels available. damaged components requested under guarantee must be returned for inspection. Failure to follow the warnings, fitting instructions contained in this document, may invalidate your guarantee. The company, its agents and representatives do not accept any product liability if used outside the EU. Use of the product in other countries outside the EU including the USA is not covered and appropriate insurance should be taken out by the user to cover for any eventuality. We reserve the rights to amend the specifications of our soccer products in the interest of continued development. Your product therefore may differ slightly to those illustrated. Not suitable for children under 36 months until assembled due to small parts.

SPARE PARTS AND NETS ARE AVAILABLE

TEL 01142434200

FOOTIEGOAL

www.footiegoals.com