





**STADIUM  
SOCKETED****21' X 7' ELLIPTICAL ALUMINIUM 120X100MM SOCKETED GOAL****1 SECTION CROSSBAR VERSION****FITTING  
INSTRUCTION****tsaGoal**  
www.itsagoal.net

TEL: 0114 24 34 200



**COMPONENTS**

<b>A</b>	CHROME BARREL LOCK & KEY	x2	
<b>B</b>	GROUND SOCKET	x2	
<b>B1</b>	SOCKET BOLT 45mm THREAD LENGTH	x2	 8mm
<b>C</b>	TWIST AND LOCK NET FIXING	x35	



**POST SECTIONS**

<b>H</b>	CROSSBAR SECTION 120mm x 100mm Diameter (Elliptical)	x1	 120mm 100mm
<b>I</b>	UPRIGHT SECTION 120mm x 100mm Diameter (Elliptical)	x2	 120mm 100mm

**OPTIONAL ITEMS****NET SUPPORT** SUPPLIED IF PURCHASED WITH GOAL.

<b>DS</b>	REMOVABLE 'D' SUPPORT	x2	
<b>J</b>	M8 WINGNUT AND HEX SCREW - 50mm LONG	x4	 8mm

**SOCKET CAP** SUPPLIED IF PURCHASED WITH GOAL.

<b>CAP</b>	OVAL LOCKING SOCKET CAP	x2	
<b>KEY</b>	HEAVY DUTY OVAL LOCKING SOCKET CAP	x2	
<b>KEY</b>	OVAL SOCKET CAP KEY	x1	

**NET** SUPPLIED IF PURCHASED WITH GOAL.

<b>NET</b>	GOAL NET	x1	
------------	----------	----	---

**ACCESSORIES** SUPPLIED IF PURCHASED WITH GOAL.

<b>GP</b>	GROUND PEG	x35	
<input type="checkbox"/>	NET RETAINER - ALLOY	x1	
<input type="checkbox"/>	NET RETAINER - STEEL	x1	

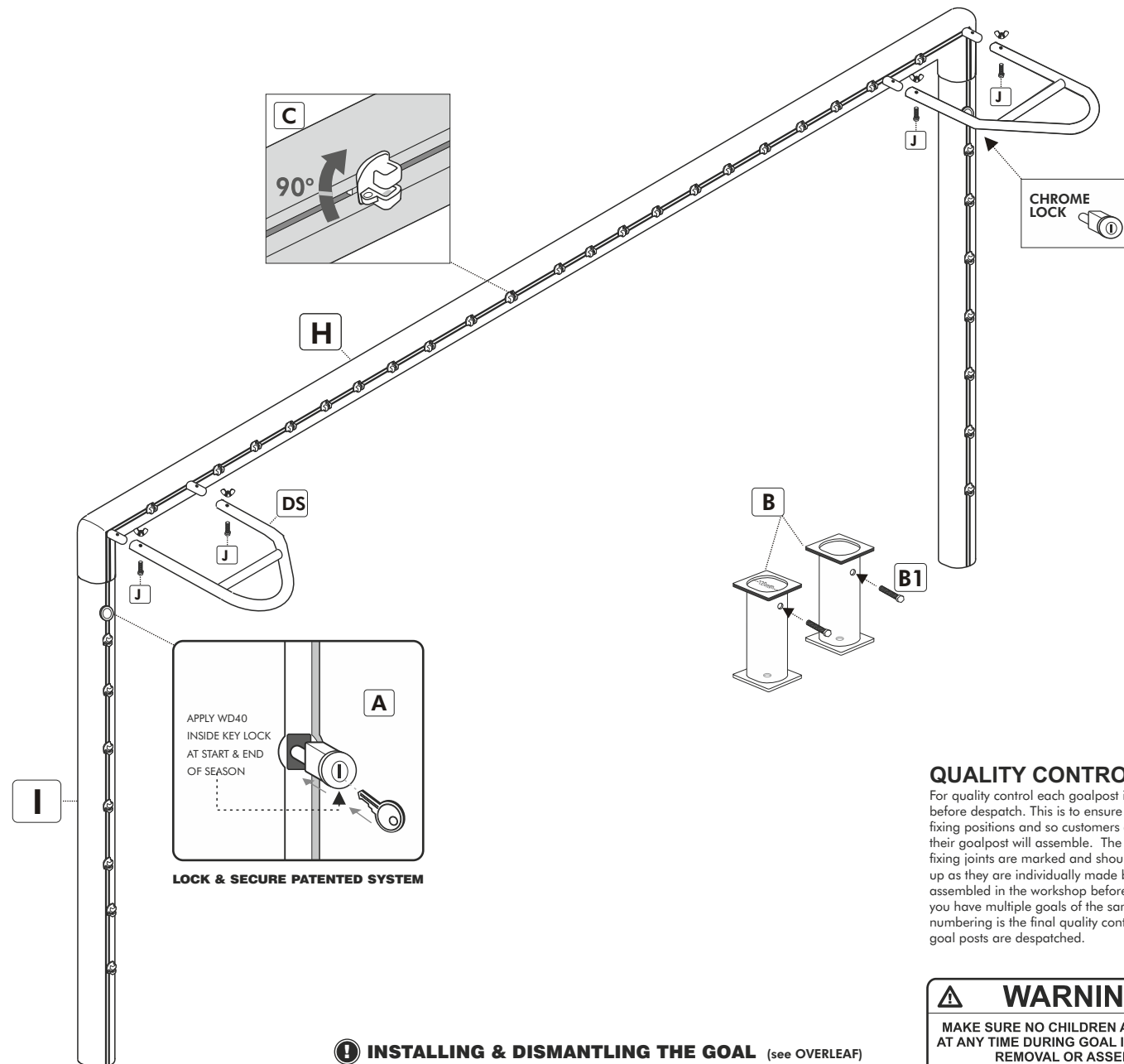
**QUALITY CONTROL**

For quality control each goalpost is assembled before despatch. This is to ensure alignment of fixing positions and so customers can be assured their goalpost will assemble. The corners and fixing joints are marked and should be matched up as they are individually made by craftsmen and assembled in the workshop before despatch. If you have multiple goals of the same type the numbering is the final quality control check before goal posts are despatched.

**WARNING**

MAKE SURE NO CHILDREN ARE PRESENT AT ANY TIME DURING GOAL INSTALLATION, REMOVAL OR ASSEMBLY.

GOALS MUST ALWAYS BE DISMANTLED IF NOT IN USE.

**INSTALLING & DISMANTLING THE GOAL** (see OVERLEAF)

For information on installing and dismantling the goal please read and follow the instructions on the other side of the page.

# GROUND SOCKET *Installation diagram*

- 1 Upright
- 2 Sport Surface
- 3 Concrete Block
- 4 Ground Socket
- 5 Drainage Hole
- 6. Socket Bolt
- 7. Pea Gravel

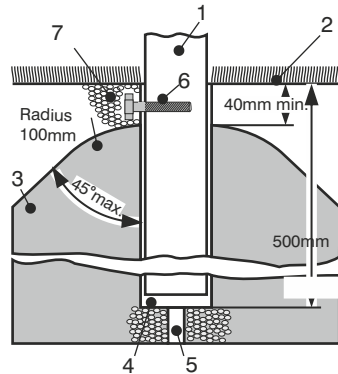

Note 'Socket bolt' must be inserted to prevent ingress of soil into ground socket. Put a dab of grease on it and insert the screw into the hole and just leave it in place. At any time in the future it can be locked'.

## IMPORTANT- GROUND SOCKET

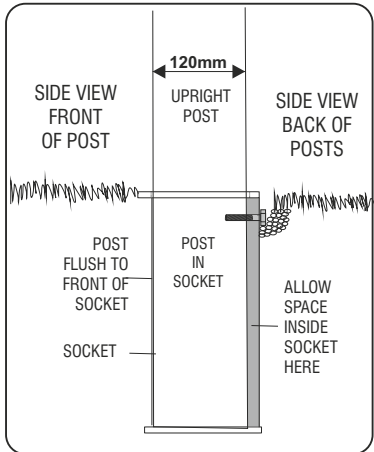

Grey area on diagram denotes the space that should be present once goal is inserted in socket. When fitting any ground socket, tape the top over to prevent concrete dropping inside the socket DURING INSTALLATION OF THE GROUND SOCKET. Locate Upright locking screw to the back of the post when fitting.

## GOAL POST in ground socket side view

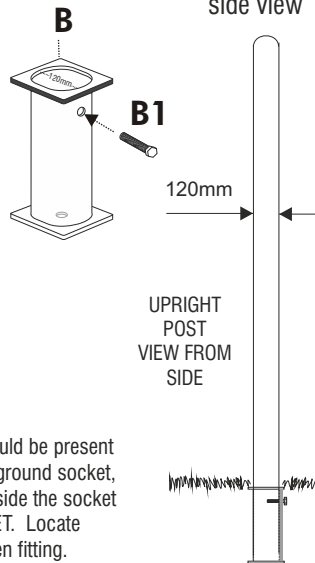

**GOALPOST PROTECTOR TAPE**  
AVAILABLE SEPARATELY

Protects paintwork at the base of the upright.

TO PURCHASE VISIT [www.soccertackle.com](http://www.soccertackle.com)

**LOCKABLE GROUND SOCKET CAPS**  
ARE AVAILABLE SEPARATELY

To cover and protect Ground Socket.

TO PURCHASE VISIT [www.soccertackle.com](http://www.soccertackle.com)



For spare parts or additional products call the goal-line 0114 2434200 or visit our online supplier [www.soccertackle.com](http://www.soccertackle.com)

## TWIST & LOCK FIXINGS

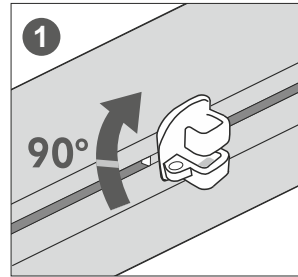

Fit into groove on goalpost section.

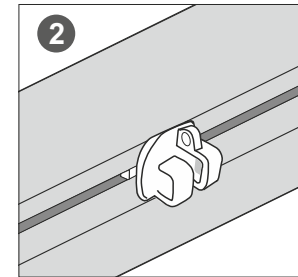

Twist 90 degrees to secure. Position the fixings no more than 340mm apart.

## NET FITTING

### STEP 1

Attach the net to the twist and lock net fixings on the crossbar and uprights. Fit the corners of the net to the top of each upright first then clip the net onto all other net fixings.

### STEP 2

Insert the red safety pegs (optional) to peg your net to the ground, fit corners first. Always insert pegs at an angle. When removing pegs use the back of a peg to take out. Do remove pegs by pulling nets.

### STEP 4

The net will have a net head cord. This is to lift the roof of the goal up behind the crossbar. Wrap the cord on the top of the net support on one side and tie off then go to the other side and pull tight and then wrap around the top support and tie off.

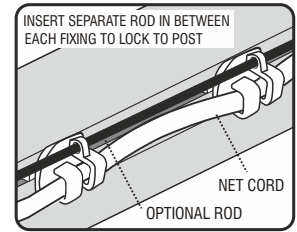

THREAD NET CORD INTO NET FIXINGS

## GROUND PEGS

LONGER GROUND PEGS ARE AVAILABLE SEPARATELY.

### STANDARD

200mm

### SOFTER GROUND

300mm

Longer pegs are to be used on sandy or soft ground earth. **A risk assessment of soil conditions suitability should be carried out when anchors are to be used.**

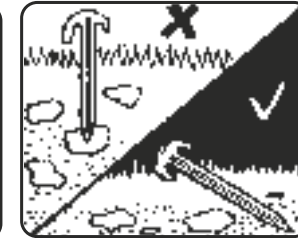
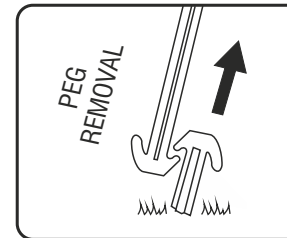

## STANDARD NET

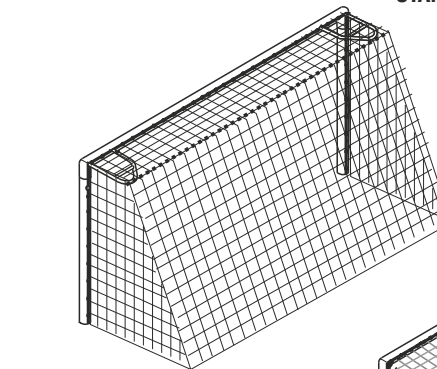

## OPTIONAL BOX NETS WITH POLES

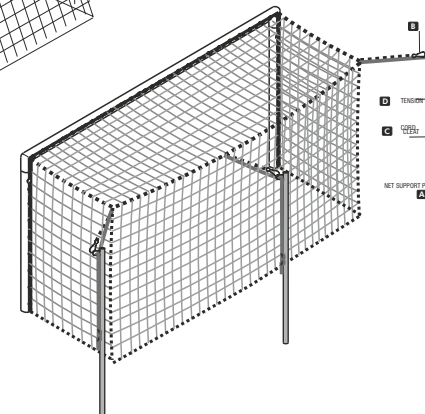

## OPTIONAL NET RETAINER

