







COMPONENTS

- A** M10 HEX NUT FOR COMPONENT B x2 
- B** M10 ROUND HEAD SQUARE NECK BOLT - 90mm LONG x2 
- C** GROUND SOCKET WITH BOLT & PLASTIC CAP x2 
- D** NYLON ARROW HEAD NET FIXING with attached LOCKING PIN x28 
- CAP** M10 HEX DOME CAP SCREW COVER - FOR COMPONENT A x2 

STEEL POST SECTIONS

- E** CROSSBAR SECTION x1 
- F** UPRIGHT SECTION x2 

OPTIONAL ITEMS

NET SUPPORT

- G** REMOVABLE 'D' SUPPORT x2 
- H** M8 WINGNUT AND HEX SCREW - 40mm LONG x4 

NET

- NET** GOAL NET 12' X 6' x1 

STEEL CAPS

- 383** STEEL SOCKET PLUG CAPS x2

ⓘ REMOVABLE 'D' SUPPORTS AND NET ARE ONLY SUPPLIED IF PURCHASED WITH GOAL.

⚠ WARNING

MAKE SURE NO CHILDREN ARE PRESENT AT ANY TIME DURING GOAL INSTALLATION, REMOVAL OR ASSEMBLY.

GOALS MUST ALWAYS BE DISMANTLED IF NOT IN USE.

STEEL NUT AND BOLT 12' X 6' BASIC

(12' x 6') - One section crossbar.

SPARE PARTS TEL: 0114 24 34 200

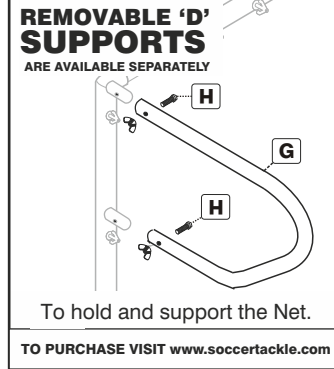

Insert the square neck bolt with flush side to front. Tap in with hammer. Tighten nut and cover with screw cover

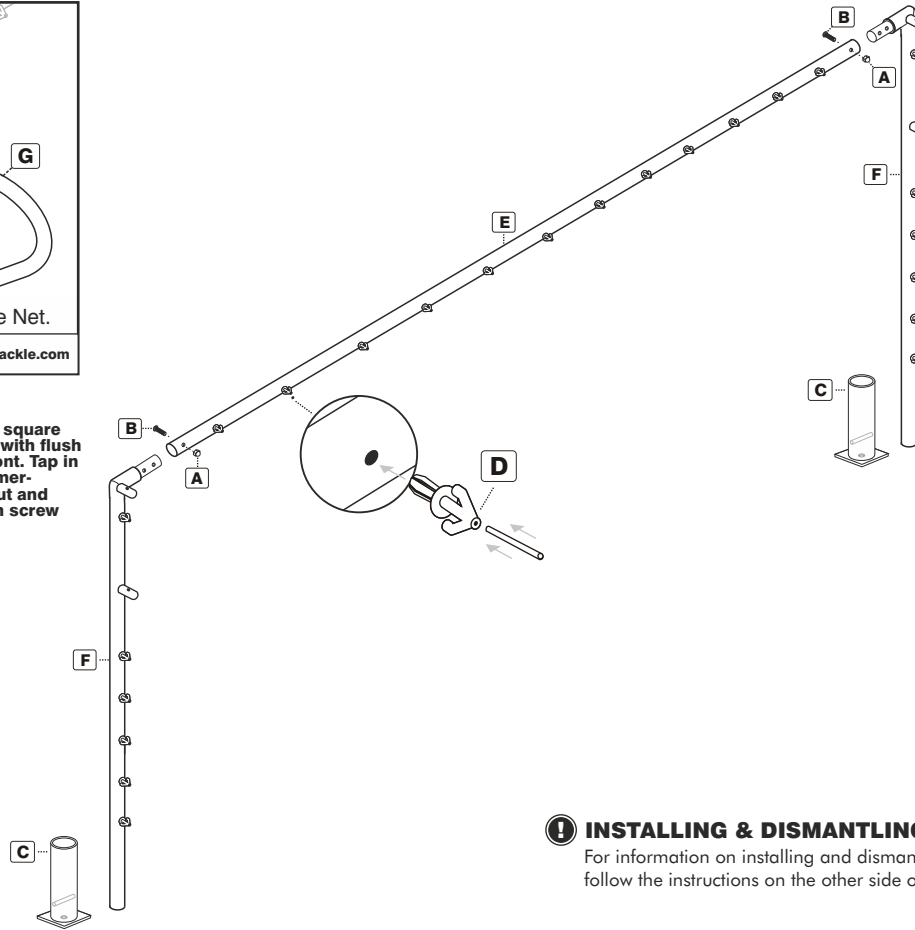

IN THE CLOSE OF SEASON

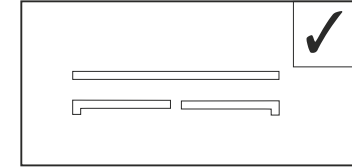

UNFASTEN CROSSBAR & UPRIGHTS AND STORE AWAY IN A SAFE PLACE.

DO NOT STORE INTACT

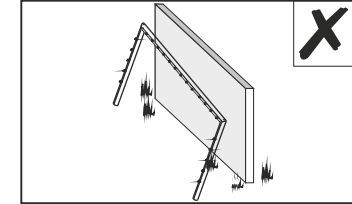

CROSSBAR & UPRIGHTS MUST BE DISMANTLED AFTER USE.

ⓘ INSTALLING & DISMANTLING THE GOAL (see OVERLEAF)

For information on installing and dismantling the goal please read and follow the instructions on the other side of the page.

GROUND PEGS

AVAILABLE SEPARATELY

STANDARD

200mm

SOFTER GROUND

300mm

Longer pegs are to be used on sandy or soft ground earth. A risk assessment of soil conditions suitability should be carried out when anchors are to be used.

TO PURCHASE VISIT www.soccertackle.com

ⓘ TYPES OF NETS & SUPPORTS AVAILABLE FOR SOCKETED GOALS

Nets and Supports sold Separately.

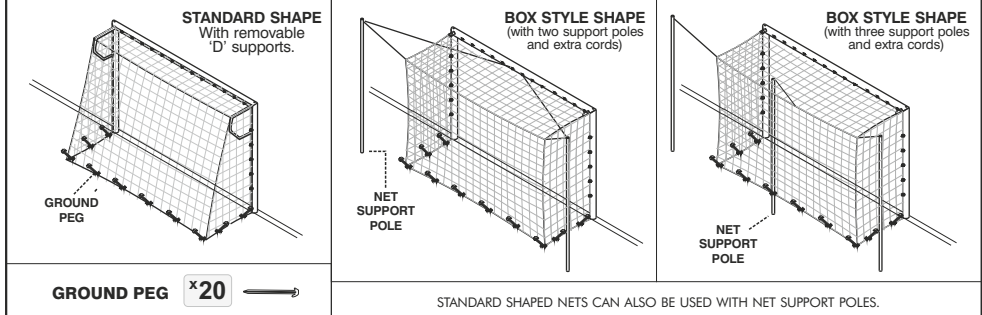

Installation of ground Sockets

1. Mark out Pitch & Check pitch is square before installing sockets. For assistance in doing this please visit(www.itsagoal.net)
2. When you are sure the pitch is square mark the position of the centre of the goal line (see overleaf)
NOTE: half the width of the goal either side of the goal line centre point = Upright positions
I.e. A 24' x 8' goal will have uprights positioned 12' either side of the centre point

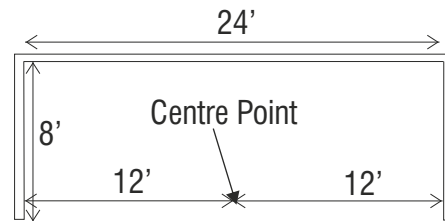

THE MEASUREMENT MUST RUN TO THE INSIDE OF THE UPRIGHTS & TO THE UNDERSIDE OF THE CROSSBAR.

3. Put one upright in at one end of the marked out pitch first. Ensure that they are at the correct height and that they are vertical not leaning to the side, backwards or forwards. (Use a level and timber supports to hold in place until concrete has hardened).

4. Once the socket has hardened and secured, you can use this with the upright inserted to support the rest of the goal whilst the second socket is concreted in place.

Position the second upright in to it's socket and fit the crossbar, bolt or lock in place. Ensure the goal is lined up correctly on your goal line. I.e. Place both uprights in with the crossbar secured in place. The first upright and crossbar attached will help to support the newly concreted second upright with crossbar attached while setting.

NEVER INSTALL GOALS WITH CHILDREN PRESENT

5. Level up the second upright as before & check crossbar is running parallel to the ground. Support second upright with timber (to prevent leaning) until concrete has hardened.

If you have not created a drainage hole in concrete - push rod through before concrete hardens off. It is a good idea to use a level on the crossbar also and then take any imperfections out in the ground level after the goal has completely settled. Never install or dismantle goalpost with children in the near vicinity. If children are likely to be drawn to your installation. Stay with goal until concrete has fully set. Do not take any risks.

These goals must only be used with the correct ground sockets provided by I.T.S.A. Goal. They must be concreted in position correctly as shown and as per the relevant safety standards. BS EN748 - BS 8462 & BS 8461 (Goal Maintenance).

You can contact our technical director on mobile 07974745768 for any help on installation.

FITTING BOX NETS

ATTACH THE NET TO THE GOAL FRAME, TO THE CROSSBAR FIRST THEN BOTH UPRIGHTS. WE ADVISE TWO CORDS BE FIXED TO THE NET AT EACH POLE POSITION. ONE CORD IS MEASURED TO THE POLE POSITION WITH A PLASTIC CLIP AND THE OTHER IS LONGER AND LOOSE TO TAKE DOWN THE NET SUPPORT POLE AND TENSION AND TIE OFF THE NET. TO INSTALL THE NET, CLIP TO EACH NET SUPPORT POLE THEN LIFT POLE INTO THE GROUND SOCKET AND THIS WILL LIFT NET INTO PLACE AND FORM THE BOX NET. USE THE SECOND CORD TO TENSION THE NET. FINALLY PEG OUT THE BASE OF THE NET OR USE GROUND FRAMES TO WEIGHT NET TO THE GROUND

MAKE SURE YOU HAVE THE LONGEST LENGTH (8') - A, FITTING ONTO THE UPRIGHT & THE SHORTEST LENGTH (5') - B, TO THE GROUND.

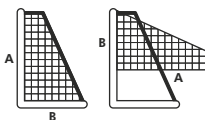

GROUND SOCKET Installation diagram

- 1 Upright
- 2 Sport Surface
- 3 Concrete Block
- 4 Ground Socket
- 5 Drainage Hole
- 6 Socket Bolt
7. Pea Gravel

Standard-Socketed installation BSEN748.cdr

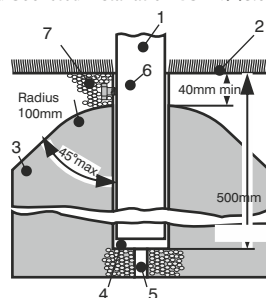

Note 'Socket bolt' must be inserted to prevent ingress of soil into ground socket. Put a dab of grease on it and insert the screw into the hole and just leave it in place. At any time in the future it can be locked'.

WARNINGS

MAKE SURE NO CHILDREN ARE PRESENT AT ANY TIME DURING GOAL INSTALLATION, REMOVAL OR ASSEMBLY

CHECK THE POSITION OF ANY UNDERGROUND SERVICES BEFORE EXCAVATION. WE TAKE NO RESPONSIBILITY FOR ANY DAMAGE OR INJURY CAUSED IN THIS MANNER.

WARNING: DO NOT TOUCH OVERHEAD SERVICES WITH POLES OR ANY PARTS. CHECK THE POSITION OF ANY OVERHEAD SERVICES WHEN SETTING UP OR DISMANTLING. POWER LINES, TELEPHONE CABELS ETC.

DO NOT SWING ON ANY NET SUPPORT POLE OR GOAL POST SECTION.

IT IS RECOMMENDED THAT AFTER USE GROUND SOCKET HOLE ARE COVERED WITH OUR CAPS THAT ARE SOLD SEPARATELY.

TO AVOID DAMAGE WHEN DISMANTLING THE GOAL FOLLOW THESE GUIDELINES: DO NOT USE ANY COMPONENTS PARTS IF THEY ARE DAMAGED OR BROKEN. IT IS ADVISABLE IN EXTREME WINDY CONDITIONS TO DISMANTLE THE GOAL AND STORE AWAY.

NET SUPPORT POLE SOCKET Installation to European Standards BS EN748

- 1 Upright
- 2 Sport Surface
- 3 Concrete Block
- 4 Ground Socket
- 5 Drainage Hole

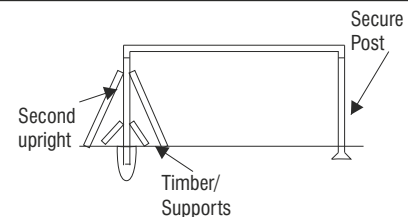
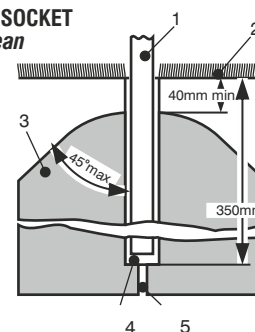

Recommended position of net support poles as per BS EN 748

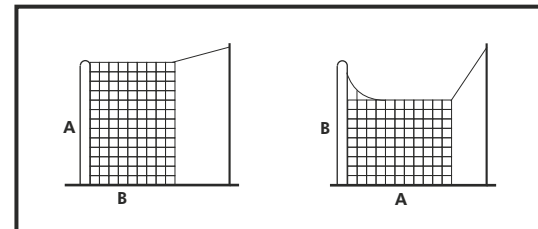
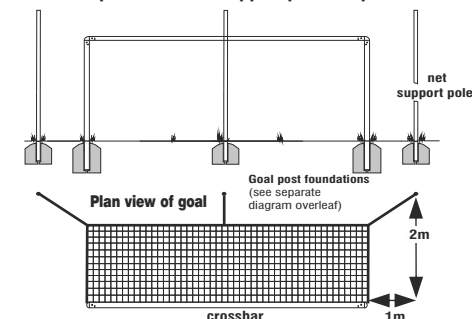

! TYPES OF NETS & SUPPORTS AVAILABLE FOR SOCKETED GOALS

Types of Nets and Supports sold Separately.

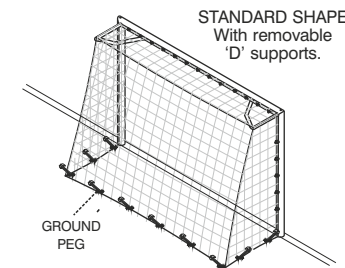

USE GROUND PEGS TO PEG NET

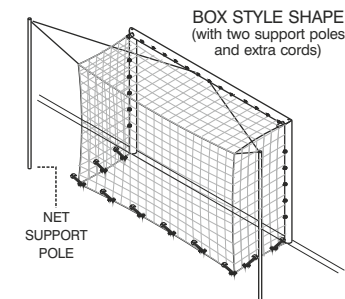

STANDARD SHAPED NETS CAN ALSO BE USED WITH NET SUPPORT POLES.

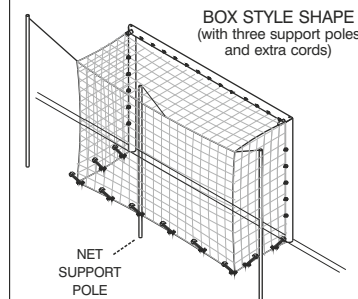

GOALPOST PROTECTOR TAPE

AVAILABLE SEPARATELY

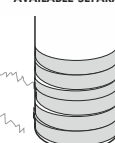

Protects paintwork at the base of the upright.

TO PURCHASE VISIT www.soccertackle.com

TWIST AND LOCK SOCKET CAPS

ARE AVAILABLE SEPARATELY

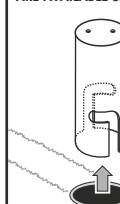

To cover and protect Ground Socket.

TO PURCHASE VISIT www.soccertackle.com



FOR FURTHER INFORMATION & ADDITIONAL FITTING INSTRUCTIONS VISIT OUR WEB SITE:

www.itsagoal.net
MEADOWHALL SOCCER CENTRE
FERRARS ROAD, TINSLEY, SHEFFIELD S9 1RZ
TEL: 0114 243 4200