













COMPONENTS

A	CORNER BRACKET	x6	
B	SPIGOT	x4	
C	BLANKING CAP	x2	
MSA	MULTI-SURFACE ANCHOR	x3	
GP	GROUND PEG	x6	
TTE	TOP TUBE ELBOW	x2	
LB	LOWER BACK STANCHION	x2	
NT	LARGE NET TIE	x46	
ST	SMALL STANCHION NET TIE	x14	
I	SMALL QUICK RELEASE BUTTON	x4	
NET	GOAL NET	x1	
SC	STRAIGHT CONNECTOR	x1	

POST SECTIONS

J	CROSSBAR SECTION 1928mm - 68mm Diameter	x1	
J1	CROSSBAR SECTION 1700mm LONG PLUS 300mm INSERT-68mm Dia.	x1	
K	BACKBAR SECTION 1814mm - 68mm Diameter	x1	
K1	BACKBAR SECTION 1814mm LONG PLUS INSERT - 68mm	x1	
L	SIDEBAR SECTION 1360mm LONG - 68mm Diameter	x2	
M	UPRIGHT SECTION 1726mm LONG - 68mm Diameter	x2	
N	TOP STANCHION TUBE 400mm LONG - 40mm Diameter	x2	
O	BACK STANCHION TUBE 1896mm LONG - 40mm Diameter	x2	

12' X 6' FOOTIEGOAL (WITH BASE) (12' X 6') -Two section Crossbar.

WORLDWIDE © COPYRIGHT 2001 ITSA GOAL POSTS LTD, ALL RIGHTS RESERVED A REGISTERED DESIGN

CE NOT SUITABLE FOR CHILDREN UNDER 36 MONTHS UNTIL ASSEMBLED DUE TO SMALL PARTS.

ANCHOR YOUR GOAL POSTS & TIE NETS TO ALL FRAMES

During a game the goal posts must have the ground anchors inserted as shown below, in order to fully hold the goal post ground sections together. The Crossbar connects into the upright posts with the corner brackets (A). It is important to fix the goal net to the larger posts with the Large Net Ties (NT). Use the Small Stanchion ties (ST) to attached the nets tightly to the net supports as indicated. See over for other helpful hints on assembly.

ST

Use the Small Stanchion ties (ST) to attach the net to the 40mm Dia net support tubes

NT

Attached the net to the larger posts with the Large Net Ties (NT). Use the Small Stanchion ties (ST) to attached the nets tightly to the net supports as indicated. See over for other helpful hints on assembly.

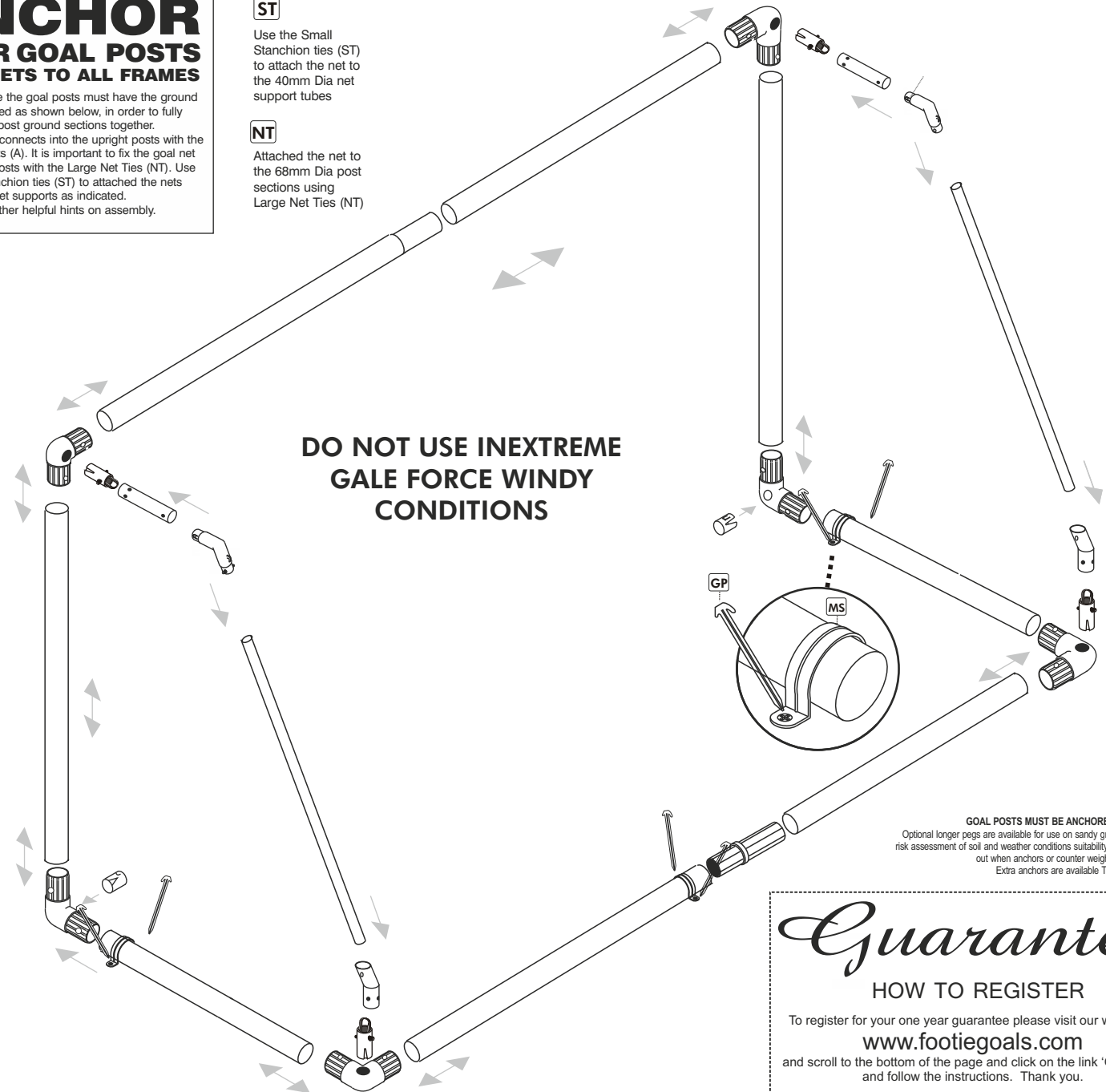

DO NOT USE IN EXTREME GALE FORCE WINDY CONDITIONS

GOAL POSTS MUST BE ANCHORED AT ALL TIMES

Optional longer pegs are available for use on sandy ground. On grass, a risk assessment of soil and weather conditions suitability should be carried out when anchors or counter weights are to be used. Extra anchors are available TEL: 0114 2434200

SPARE PARTS AND NETS ARE AVAILABLE

TEL 01142434200 www.footiegoals.com

WE RESERVE THE RIGHTS TO AMEND THE SPECIFICATIONS OF OUR SOCCER PRODUCTS IN THE INTEREST OF CONTINUED DEVELOPMENT. YOUR PRODUCT THEREFORE MAY DIFFER LIGHTLY TO THOSE ILLUSTRATED. E&OE

Guarantee

HOW TO REGISTER

To register for your one year guarantee please visit our web page

www.footiegoals.com

and scroll to the bottom of the page and click on the link 'Guarantee' and follow the instructions. Thank you.

CORNER BRACKETS

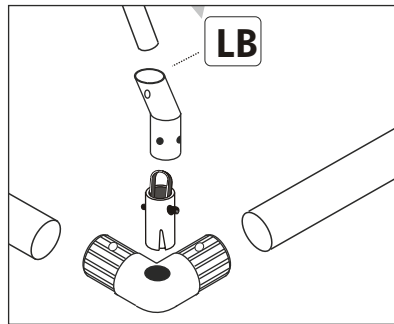
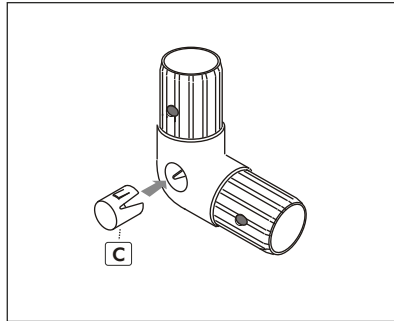
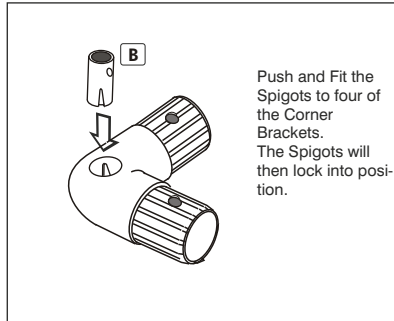

CORNER BRACKET, STANCHION & ELBOW ASSEMBLY

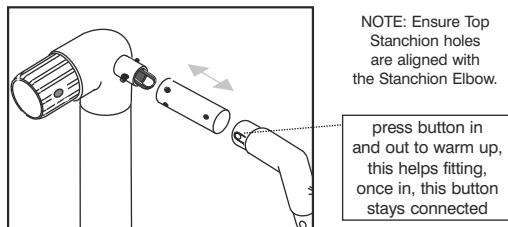

NET TIES : Place the small stanchion net ties on the net support stanchions. This will help extend the life of your net and keep the frame tightly fitted together. Apply the larger ties to the ground frame and the posts. We recommend placing the net ties no more than 340mm apart. The net ties supplied are designed to permanently fix the net to the goal frame. If you require to take nets on and off, other net fixings can be used.

NOTE: Goal must be anchored otherwise breakages may occur. In extreme conditions it is advised to store away. The best way to store your goal is to remove crossbar and rear back bar section leaving the net attached to the side frames. If you do this regularly then it is advisable to buy optional removable net ties. The goals are ideal when left with nets attached, for example in a garden. You must anchor your goals with the multi surface ground anchors provided. At the end of the season nets can be tied into a bundle and placed into a pillow case (not to damage washing machine) and washed at 40 C0 with normal washing powder. The ground frame can be washed with hot soapy water. Any scuff marks on posts can be rubbed off with a light abrasive scouring pad.

WARNING: Check the position of any underground services before using the ground anchors and pegs. We take no responsibility for any damage or injury caused in this manner.

NEVER use the goals without the ground anchor system. In severe weather or windy conditions it is advisable to take your goal down as damage is not covered by the guarantee in such circumstances. If you find the nets are worn along the floor it may be rodents, by spreading pepper along the base frame rodents will be deterred. It is advisable in any contact sport to take out the relevant insurance's to cover against injury both from taking part, equipment and other unforeseeable circumstances.

Crossbars will not be replaced within the guarantee period if broken by swinging or climbing or any other misuse. **DO NOT** try to glue any damaged fixings. Plastic materials in this product vary and this may cause the plastic to break. Always replace any damaged components.

NOTE : All plastic extrusions vary and therefore some tubes may be looser or tighter to connector fittings. If you want to increase the diameter of the fitting just wrap masking tape around the part that fits into the tube, twist as you insert the fitting and it will grab to the tube tight. You can make tighter fits by adding more tape.

SQUARE MESH Net is cut to shape. Simply throw over the frame and fit each end onto top stanchion by securing on each corner of crossbar.

NOTE: If your net does not fit the first time, you may be fitting it to the goal frame upside down i.e. that is to say the net from the crossbar to the floor (a) is longer than the length of the net to the bottom of the upright.(b)

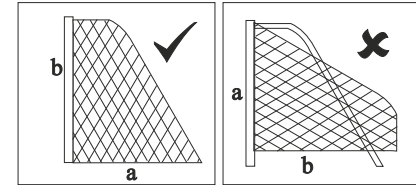

We advise adult supervision during assembly and use. Observe and follow warning labels attached to goal. Do not use any components, nets or parts if they are damaged or broken. Spare parts and replacement nets are readily available. If others are to install your goal you should show them how to erect and dismantle the goal and hand them a copy of the fitting instruction. If you lose your instructions copies can be attained from our company website. To avoid damage when dismantling the goal follow these guidelines: it is advisable in extreme windy conditions to dismantle the goal and store away. Do not drop any heavy objects on ends of tubes. When dismantling the goal ensure that all fittings are packed away and that non are left on the playing surface. Warning goals must never be left up or used unless they are properly fitted with ground anchors with net attached and securely pegged down.

Hard surfaces: to prevent damage to goal or it's components, loosen soil with a steel pole and moisten with some water before inserting the ground anchors. Do not use the goal in sub zero temperatures. warning labels should be replaced when worn and we recommend replacing them every two years -spare labels available. damaged components requested under guarantee must be returned for inspection. Failure to follow the warnings, fitting instructions contained in this document, may invalidate your guarantee. The company, its agents and representatives do not accept any product liability if used outside the EU. Use of the product in other countries outside the EU including the USA is not covered and appropriate insurance should be taken out by the user to cover for any eventuality. We reserve the rights to amend the specifications of our soccer products in the interest of continued development. Your product therefore may differ slightly to those illustrated. Not suitable for children under 36 months until assembled due to small parts.

SPARE PARTS AND NETS ARE AVAILABLE

TEL 01142434200

FOOTIEGOAL

www.footiegoals.com